

DENTAL INSTRUMENTS CATALOGUE



Vision Instrument Company

MANUFACTURER & EXPORTER OF FINE QUALITY
SURGICAL, DENTAL & BEAUTY, INSTRUMENT





Vision Instrument establish a global presence as a dealing of high quality handheld surgical instruments in the Dental, Eye Surgery, Micro Surgery, General Surgery, Beauty Instruments and Veterinary. Our goal will be achieved by offering excellent products and services; and by our commitment to exceed customer expectations.

Our experience taught us that innovative and top quality dental instruments are essential criteria for the competence of a dentist. The requirements of the dentist have customized our new and future developed instruments because contemporary and advanced application techniques need high tech instruments. For developing our instruments, we have the support of world renowned practicing dentists and experts.



Vision Instrument Der Aufbau einer globalen Präsentation als handeln von qualitativ hochwertigen chirurgischen Handinstrumenten im Bereich der Dental chirurgie, Augen Chirurgie, Mikro Chirurgie, Allgemeine Chirurgie, und Veterinär. Unser Ziel wird erreicht durch unser Angebot an herausragenden Produkten und Dienstleistungen. Die Erwartungen unserer Kunden sind unsere Vorgabe.

Unsere Erfahrung lehrt uns, dass innovative und hochwertige zahnmedizinische instrumente ein entscheidendes kriterium für die kompetenz eines zahnarztes sind. Unsere neu und weiterentwicklungen der instrumente sind auf die Bedürfnisse der Zahnärzte angepasst, zeitgemaße Anwendungstechniken benötigen fortschrittliches instrumentarium. Bei der produktentwicklung warden wir von weltweit anerkannten praktikern unterstützt.



Vision Instrument Company

MANUFACTURER & EXPORTER OF FINE QUALITY
SURGICAL, DENTAL & BEAUTY, INSTRUMENT

Marala Road, Chowk Kotli Loharan, Sialkot - Pakistan

Tell : +92 344 6398925

E-mail : visioninstco@gmail.com info@visioninstco.com

URL : www.visioninstco.com



01



EXTRACTING FORCEPS

Page # 01 - 14

02



ROOT ELEVATORS

Page # 15 - 29

03



DIAGNOSTIC, PROBES, SCALERS, FILLING & LABORATORY INSTRUMENTS

Page # 30 - 77

04



MAXILLOFACIAL SURGERY INSTRUMENTS

Page # 78 - 95

05



ORTHODONTIC INSTRUMENTS & PLIERS

Page # 96 - 107

06



DENTAL IMPLANT INSTRUMENTS

Page # 108 - 142

07

Impression Tray & Hollow wares

Page # 143 - 148

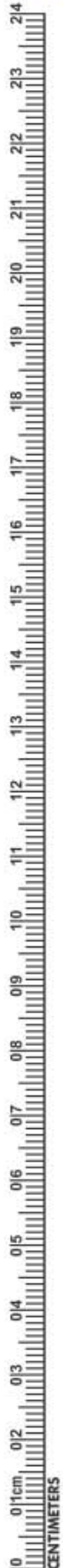

EXTRACTING FORCEPS



HANDLE GRIP AVAILABLE
A, B, C, D

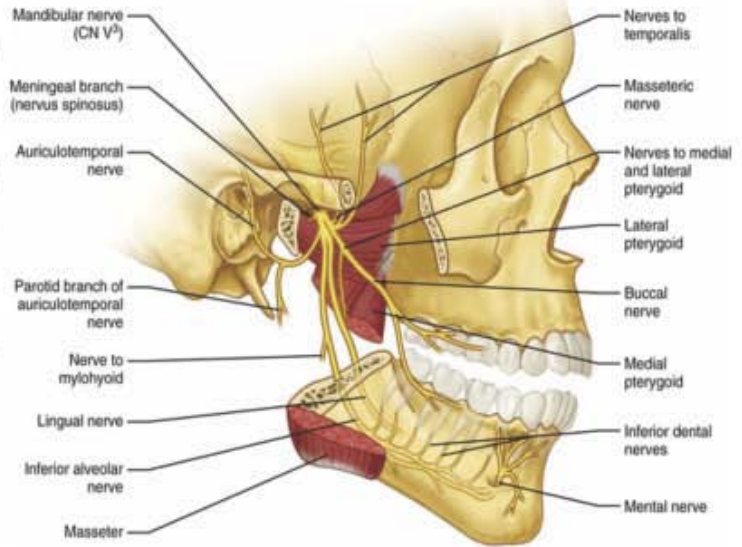
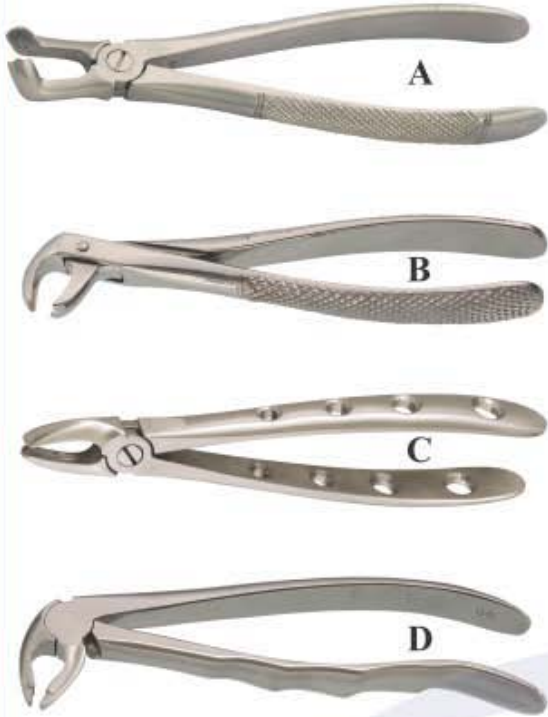

- Щипцы экстракционные (английская форма)
- Daviers (Forme Anglaise)
- Zahnzangen (Englische Form)
- Щипці екстракційні (англійська форма)
- Forceps de Extracción (Forme Inglesa)
- استخراج المنقط (نمط اللغة الإنجليزية)

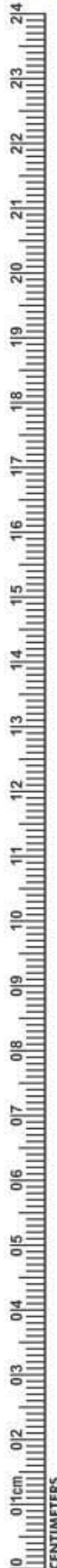

DE-001
Fig. 23
Syndesmotome lower roots



DE-002
Fig. 24
Syndesmotome upper molar



DE-003
Fig. 25
Syndesmotome Lower molar forceps



DE-004
Fig. 79
Lower Wisdoms



DE-005
Fig. 60
Upper roots, extra slim jaws



DE-006
Fig. 62
Upper roots, extra slim jaws



DE-007
Fig. 74
Upper roots and incisors



DE-008
Fig. 33
Lower Roots



DE-009
Fig. 51
Upper Roots



DE-010
Fig. 61
upper Roots, short,
extra slim jaws



DE-011
Fig. 67
upper wisdoms,
either sides



DE-012
Fig. 86
lower molars decayed or
with broken down crown

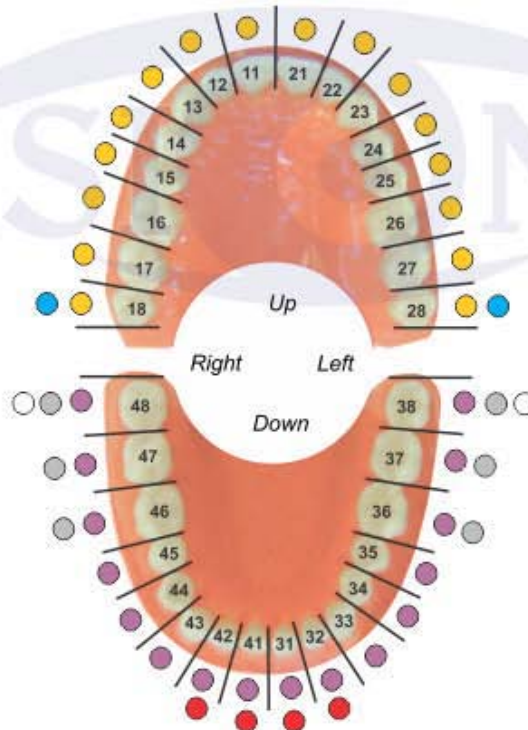

EXTRACTING FORCEPS (English Pattern)



- Щипцы экстракционные (английская форма)
- Daviers (Forme Anglaise)
- Zahnzangen (Englische Form)

- Щипці екстракційні (англійська форма)
- Forceps de Extracción (Forme Inglesa)
- استخراج الملقط (نمط اللغة الإنجليزية)



DE-013
Fig. 01
upper centrals and canines



DE-014
Fig. 04
Lower incisors and Canines



DE-015
Fig. 08
Lower Bicuspid



DE-016
Fig. 17
Upper right molars



DE-017
Fig. 73
Lower molars



DE-018
Fig. 21
Lower molars



DE-019
Fig. 02
upper incisors and canines



DE-020
Fig. 07
Lower Canines and bicuspid



DE-021
Fig. 13
Lower Canines and bicuspid



DE-022
Fig. 18
Upper Left Molars



DE-023
Fig. 22
Lower molars - Untere Molaren



DE-024
Fig. 75
Lower canines and bicuspid

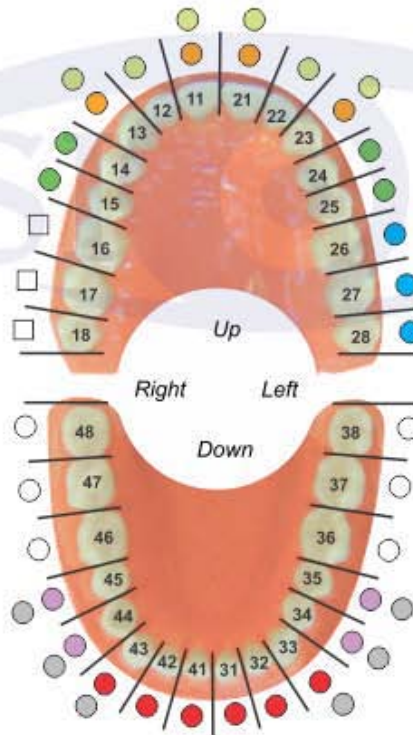

- Щипцы экстракционные (английская форма)
- Daviers (Forme Anglaise)
- Zahnzangen (Englische Form)
- Щипці екстракційні (англійська форма)
- Forceps de Extracción (Forme Inglesa)
- استخراج الملقط (نمط اللغة الإنجليزية)

Apical Set of 9 Pcs (Deep Gripe Extracting Forceps)



- No Fracture
- No Tissue Damage
- Extraction With Easy

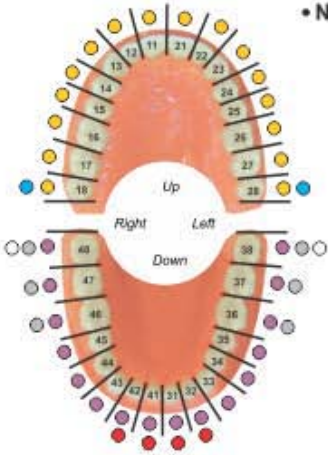

DE-029
F-2
LOWER UNIVERSAL



DE-030
F-4
LOWER ANTERIOR



DE-025
F-1
UPPER UNIVERSAL



DE-031
F-4
LOWER ANTERIOR



DE-026
F-1
UPPER UNIVERSAL



DE-032
F-6
UPPER 3RD



DE-027
F-3
UPPER ANTERIOR



DE-028
F-3
UPPER ANTERIOR



DE-033
F-7C
LOWER MOLAR

A-TRAUMATIC EXTRACTION SET

Improved tapered beaks for complete root contact. Cross serrations for a never slip grasp. Easily enter the sub gingival.

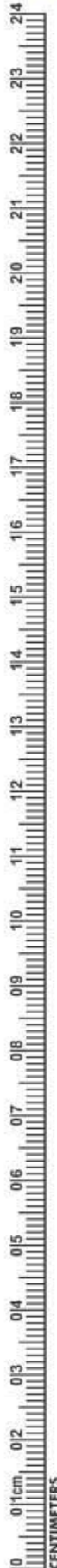

EXTRACTING FORCEPS (English Pattern)



- Щипцы экстракционные (английская форма)
- Щипці екстракційні (англійська форма)
- Daviers (Forme Anglaise)
- Forceps de Extracción (Forme Inglesa)
- Zahnzangen (Englische Form)
- استخراج الملقط (نمط اللغة الإنجليزية)



Fig. 79A



Fig. 45Z



Fig. 51Z



Fig. 44Z



Fig. 46



Fig. 67



Fig. 67A



Fig. 79



DE-034
Fig. 9
Apex Forceps Lower Universal
Deep Root Pick



DE-035
Fig. 187
Apex Forceps Lower Root
Deep Root Pick



DE-036
Fig. 189
Apex Forceps
Upper Root
Deep Root Pick



DE-037
Fig. 190
Apex Forceps Upper Root
Deep Root Pick



DE-038
Fig. 46XL
Apex Forceps Lower Root
Deep Root Pick

DEEP ROOT PICK FORCEPS (Apical Set of 9)

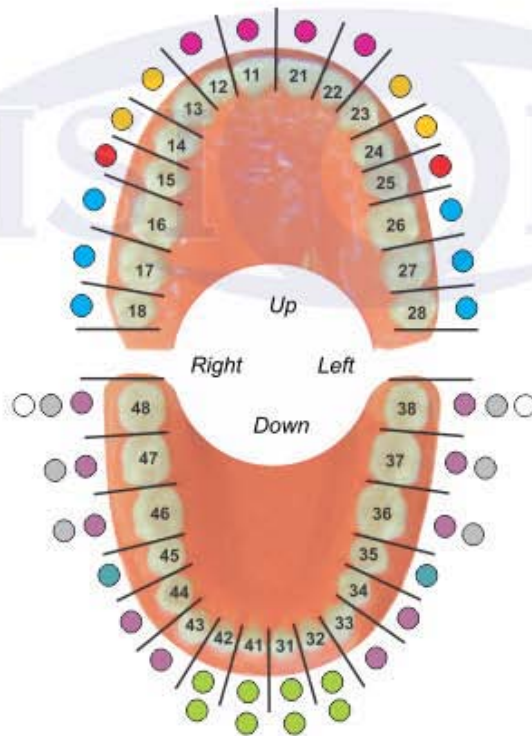

DE-039
Fig. 67
Upper Third Molars



DE-040
Fig. 67A
Upper Third Molars



DE-041
Fig. 79
Lower Third Molars



DE-042
Fig. 37
Lower Root Molars



- Щипцы экстракционные (английская форма)
- Daviers (Forme Anglaise)
- Zahnzangen (Englische Form)

- Щипці екстракційні (англійська форма)
- Forceps de Extracción (Forme Inglesa)
- استخراج الملقط (نمط اللغة الإنجليزية)

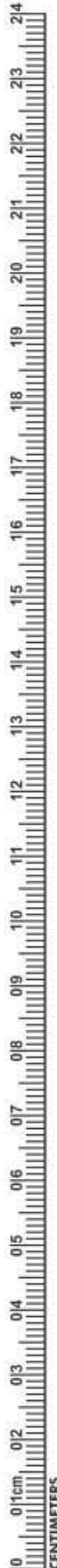

DE-043
Fig. 2
upper laterals and canines



DE-044
Fig. 7
Upper Premolars/Bicuspids



DE-045
Fig. 17
Upper Molars, Right



DE-046
Fig. 18
Upper Molars, Left



DE-047
Fig. 67
upper third molars

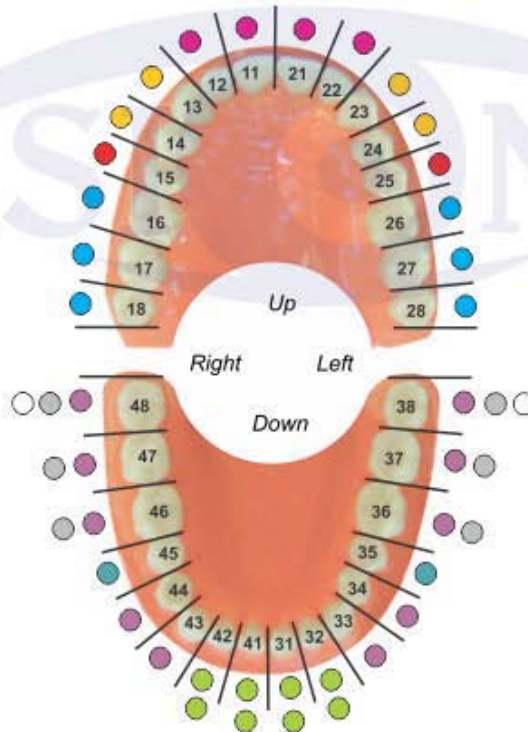

DE-048
Fig. 13
Lower Premolars/
Bicuspids



DE-049
Fig. 22
Lower Molars



DE-050
Fig. 33
lower roots



DE-051
Fig. 51
upper roots



DE-052
Fig. 79
Lower third molars

EXTRACTING FORCEPS (English Pattern)



- Щипцы экстракционные (английская форма)
- Щипці екстракційні (англійська форма)
- Forceps de Extracción (Forme Inglesa)
- (استخراج الملقط (تمط اللغة الإنجليزية)
- Daviers (Forme Anglaise)
- Forceps de Extracción (Forme Inglesa)
- Zahnzangen (Englische Form)



DE-053
Fig. 1
upper laterals
and canines



Extracting Forceps
Set of 10 Pcs
Detail of Pack
Forceps
Fig. 1
Fig. 2
Fig. 73
Fig. 67
Fig. 51A
Fig. 74
Fig. 51
Fig. 17
Fig. 7
Fig. 13



DE-054
2
upper laterals
and canines



DE-055
73
lower molars



DE-056
67
upper third
molars

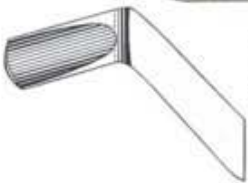

DE-057
51 A
upper roots



DE-058
74
lower roots



DE-059
51
upper roots



DE-060
17
upper molars,
right



DE-061
7
upper premolars



DE-062
13
lower premolars

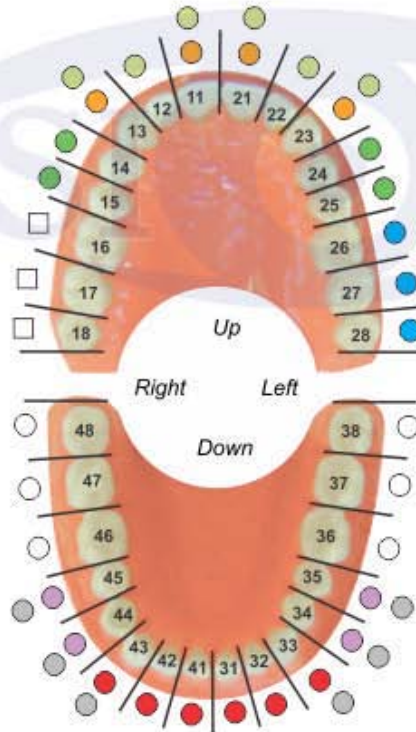

- Щипцы экстракционные (английская форма)
- Daviers (Forme Anglaise)
- Zahnzangen (Englische Form)

- Щипці екстракційні (англійська форма)
- Forceps de Extracción (Forme Inglesa)
- استخراج الملقط (نمط اللغة الإنجليزية)

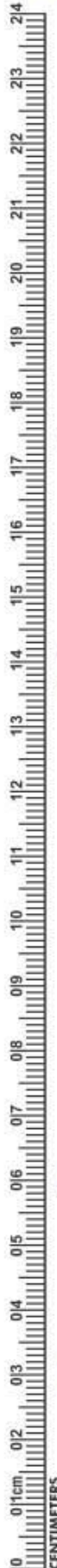

Set of 10 Pieces
 Fig. 1
 Fig. 7
 Fig. 13
 Fig. 17
 Fig. 18
 Fig. 22
 Fig. 33A
 Fig. 51A
 Fig. 67A
 Fig. 79



DE-063
 Fig. 1
 Upper Centrals
 & Canines/Cuspids



DE-068
 Fig. 22
 Lower Molars



DE-064
 Fig. 7
 Upper Premolars/
 Bicuspsids



DE-069
 Fig. 33A
 Lower Roots
 Narrow tips



DE-065
 Fig. 13
 Lower Premolars/
 Bicuspsids

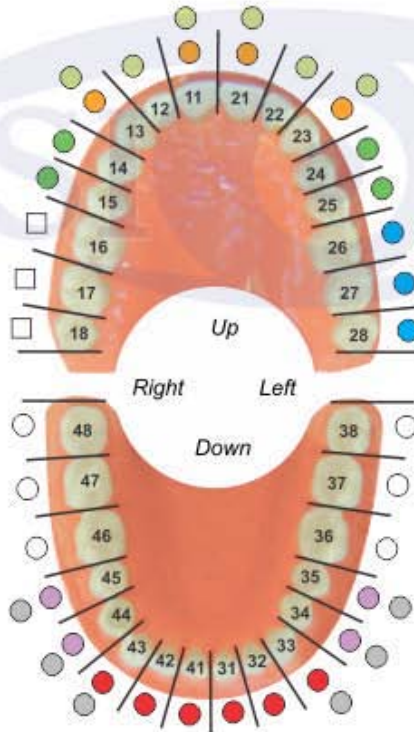

DE-066
 Fig. 17
 Upper Molars,
 Right



DE-070
 Fig. 51A
 Upper roots
 narrow tips



DE-067
 Fig. 18
 Upper Molars,
 Left



DE-071
 Fig. 67A
 Upper third
 molars



DE-072
 Fig. 79
 Lower third
 molars

EXTRACTING FORCEPS



- Щипцы экстракционные
- Давиеры
- Zahnzangen
- Щипці екстракційні
- Forceps de Extracción
- استخراج الملقظ

Pediatric Tooth Extracting Forceps Set



DE-074
English Pattern Klein #51S
Pedodontic Upper root



DE-073
English Pattern Klein #137
Pedodontic, Upper Incisors
Spring handle



DE-077
English Pattern Klein #5
Pedodontic Lower Incisors.



DE-075
English Pattern Klein #139
Pedodontic Upper Premolars



Baby Tooth Extraction Forceps

Fig. # 01 to 07
Set of 7 Pieces



DE-078
English Pattern Klein #7
Pedodontic Lower Roots,



DE-076
English Pattern Klein #3
Pedodontic Upper Molars
Universal

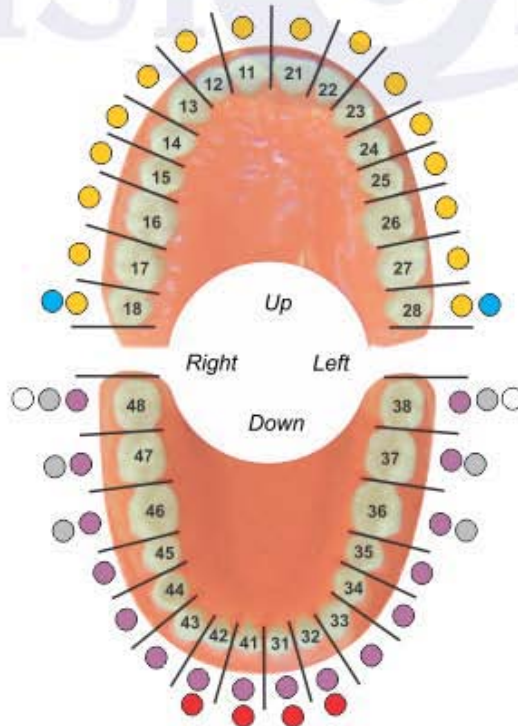

DE-079
English Pattern Klein #6
Pedodontic Lower Molars,
Spring Handle



- Щипцы экстракционные
 - Daviers
 - Zahnzangen
- Щипці екстракційні
 - Forceps de Extracción
 - استخراج الملقط

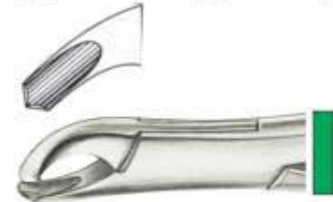
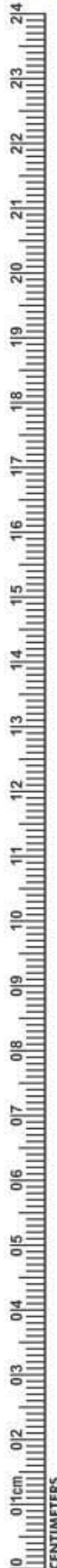

DE-080
Fig. 17 SK
Lower molars



DE-084
Fig. 17S
Lower, molars



DE-081
Fig. 150 SK
Upper anteriors and roots



DE-085
Fig. 18LS
upper, molars left



DE-082
Fig. 151 SK
lower anteriors and roots



DE-086
Fig. 18RS
upper, molars right



DE-083
Fig. 90
Upper molars, left



DE-087
Fig. 65S
upper incisors and roots



DE-088
Fig. 69S
upper and lower roots

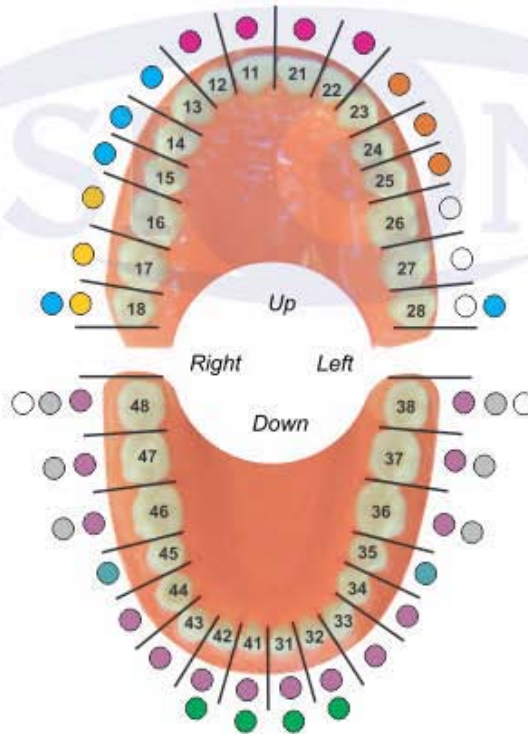

EXTRACTING FORCEPS (American Pattern)

- Щипцы экстракционные (американская форма)
- Давиеры - forme americane
- Fórceps de extracción - forma americana
- Щипці екстракційні (американська форма)
- Pinzere per estrazione - forma americana
- استخراج الملقط (الأمريكي)

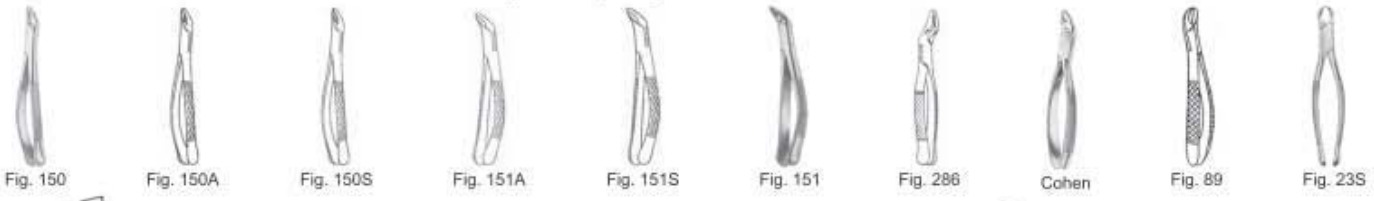

DE-089
150
Cryer upper incisors, premolars, roots



DE-094
151
Cryer lower teeth, for children

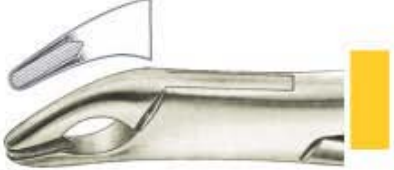

DE-090
150A
Cryer upper incisors, premolars, roots



DE-095
286
upper incisors and roots



DE-091
150S
Cryer upper teeth, for children

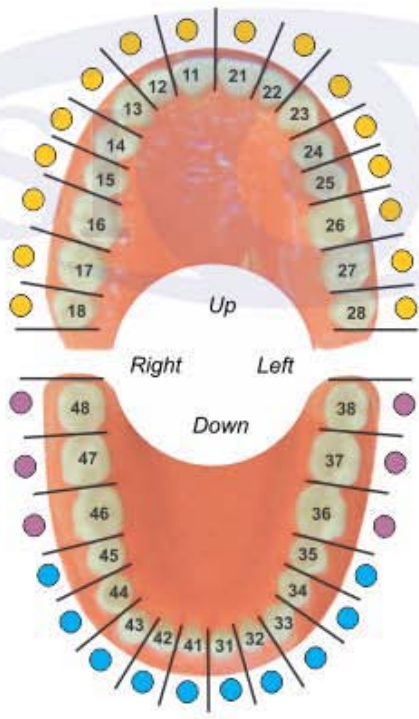

DE-092
151A
Cryer lower incisors, premolars, roots



DE-096
Cohen universal forceps



DE-097
89
Upper molars, right



DE-093
151 S
Cryer lower incisors, premolars, roots



DE-098
23 S
Lower molars



- Щипцы экстракционные (американская форма)
- Daviers - forme américaine
- Férceps de extracción - forma americana
- Щипці скстракційні (американська форма)
- Pinzere per estrazione - forma americana
- استخراج المنقط (المنقط الأمريكي)

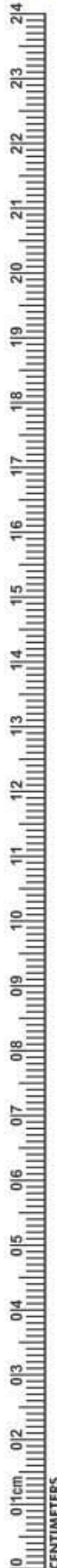
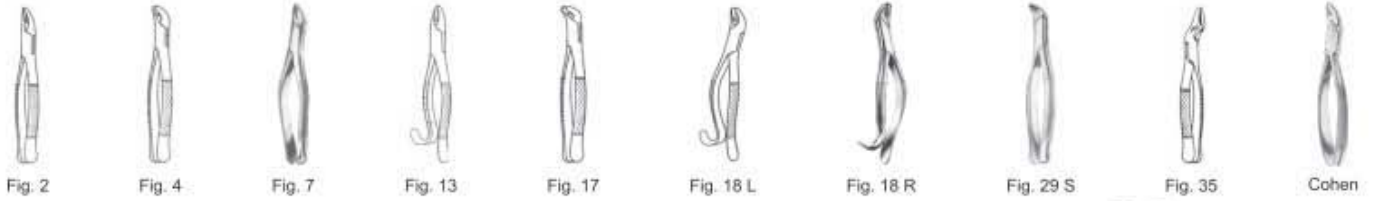

DE-099
2
upper and lower roots



DE-104
18 L
Harris upper molars, left



DE-100
4
upper and lower premolars



DE-105
18R
Harris upper molars, right



DE-101
7
upper roots

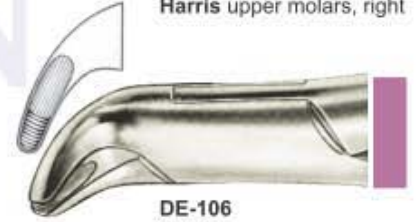

DE-106
29S
lower teeth, for children



DE-102
13
upper incisors



DE-107
35
upper roots



DE-103
17
lower molars



DE-108
Cohen
universal forceps

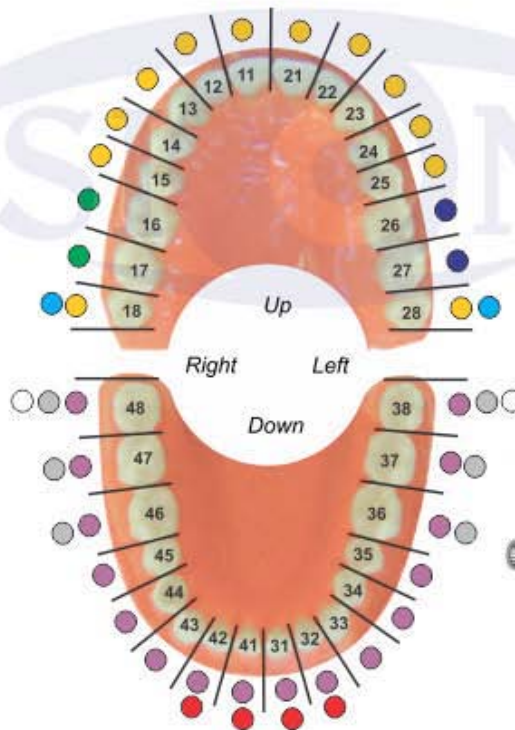

EXTRACTING FORCEPS (American Pattern)

- Щипцы экстракционные (американская форма)
- Daviers - forme américaine
- Férceps de extracción - forma americana
- Щипці екстракційні (американська форма)
- Pinzere per estrazione - forma americana
- استخراج الملقط (النمط الأمريكي)



DE-109
Fig. 1
Upper Anterior

DE-110
Lower Molar
Fig. 23 Cow Horn



DE-111
Fig. 74
Lower Anterior



DE-112
Fig. 88L
Upper Molar Left



DE-113
Fig. 88R
Upper Molar Right



DE-114
Fig. 74
Lower Anterior



DE-115
Fig. 106
Lower Incisors



DE-116
Fig. 174
Extra Narrow
Lower Anterior
Apical Retention
Forceps



DE-117
Fig. 859
Lower Molars
Roots



- Шприцы стоматологические карпульные
- Seringues à usage dentaire
- Dentalspritzen
- Шприці стоматологічні карпульні
- Jeringas dentales
- المحاقن الأسنان

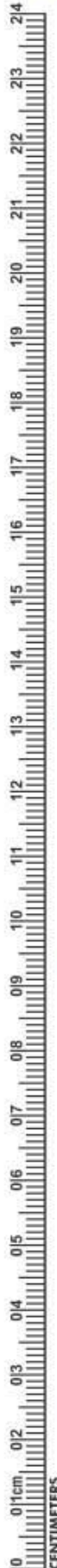

DE-118 1.8ML
DE-119 2.2ML



DE-120 1.8ML
DE-121 2.2ML



DE-122 1.8ML
DE-123 2.2ML



DE-124 1.8ML
DE-125 2.2ML



DE-126 1.8ML
DE-127 2.2ML



DE-128 1.8ML
DE-129 2.2ML



DE-130
1001
Intraligamental
Anesthesia Syringe
in Black Colour



DE-131 1.8ML
DE-132 2.2ML
Angled



DE-133
Aluminium - Dark 1.8 ml



DE-134
Aluminium - Silver 1.8 ml



DE-135
Aluminium - Orange 1.8 ml



DE-136
Aluminium - Green 1.8 ml



DE-137
Aluminium - Blue 1.8 ml

BONE ROUNGER



- Костные кусачки
- Hohlmeißelzangen
- Pincés-gouges
- Кусачки для кісток
- Pinzas-gubias
- روجوريس العظام



DE-138
Blumenthal
15cm



DE-139
Blumenthal
15cm



DE-140
Blumenthal
15cm



DE-141
Friedman
14cm



DE-142
Friedman
14.5cm



DE-143
Micro-Friedman
14cm



DE-144
Micro-Friedman
15cm



DE-145
Micro-Friedman
16cm



DE-146
Kleinert-Kutz
18.5cm



DE-147
Beyer
18.5cm



DE-148
Mead 1A
18.5cm



DE-149
Luer
18.5cm



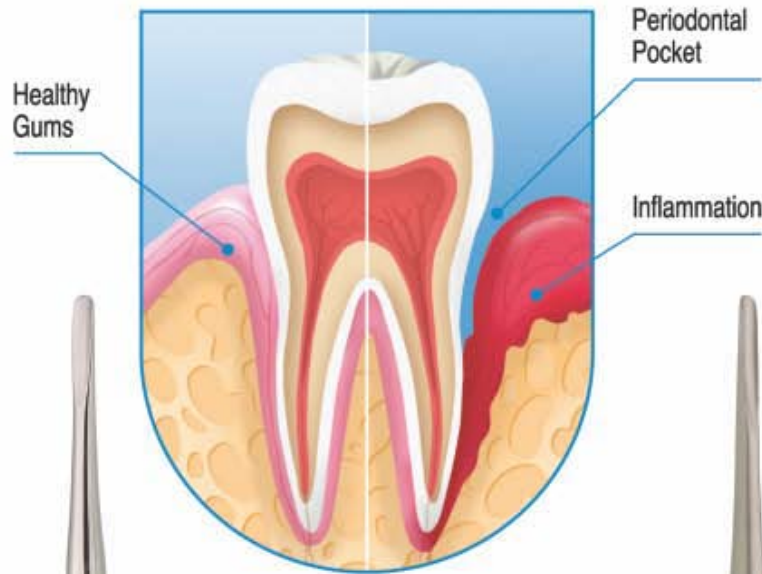
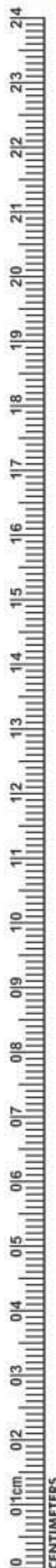

**HANDLES FOR ROOT ELEVATORS POINTS
A, B, C, D**

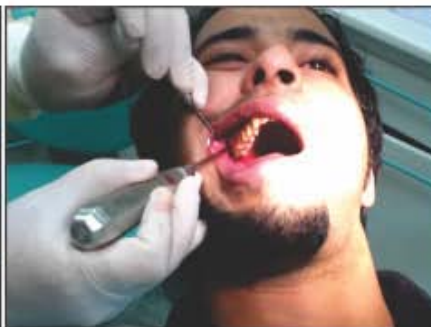
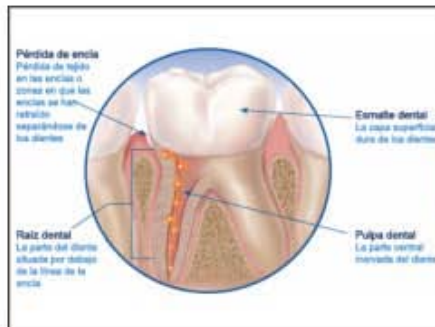

ROOT ELEVATOR



- Элеватор корневой экстракционный
- Elévateurs à racines
- Wurzelheber
- Слеватор корневий экстракційний
- Elevadores para raices
- المعاعد الجذر

Apexo Root Elevators



Apexo



DE-150
Apexo
2.5x9mm
Straight



DE-151
Apexo
2.7x9mm
Straight



DE-152
Apexo
3.0x9mm
Straight



DE-153
Apexo
2.5x9mm
Curved



DE-154
Apexo
3.0x9mm
Curved



DE-155
Seldin
3.0x14mm
Straight

Luxator Root Elevators



Luxator



DE-156
Luxator
3mm
straight



DE-157
Luxator
3mm
curved



DE-158
Luxator
4mm
straight



DE-159
Luxator
4mm
curved



DE-160
Luxator
5mm
straight



DE-161
Luxator
5mm
curved

Bein Root Elevators



Bein



DE-162
Bein 2mm



DE-163
Bein 3mm



DE-164
Bein 4mm

Seldin Root Elevators



Seldin



DE-165
Floh 1



DE-166
Seldin 34S



DE-167
Seldin 34



- Элеватор корневой экстракционный
- Elévateurs à racines
- Wurzelheber

- Elevator corneveiey ekstraktsionnyy
- Elevadores para raices
- المصاعد الجذر

Apexo Root Elevators



Apexo



DE-168
Apexo
2.5x9mm
Straight



DE-169
Apexo
2.7x9mm
Straight



DE-170
Apexo
3.0x9mm
Straight



DE-171
Apexo
2.5x9mm
Curved



DE-172
Apexo
3.0x9mm
Curved



DE-173
Seldin
3.0x14mm
Straight

Luxator Root Elevators



Luxator



DE-174
Luxator
3mm
straight



DE-175
Luxator
3mm
curved



DE-176
Luxator
4mm
straight



DE-177
Luxator
4mm
curved



DE-178
Luxator
5mm
straight



DE-179
Luxator
5mm
curved

Bein Root Elevators



Bein



DE-180
Bein 2mm



DE-181
Bein 3mm



DE-182
Bein 4mm

Seldin Root Elevators



Seldin



DE-183
Flohr 1



DE-184
Seldin 34S



DE-185
Seldin 34

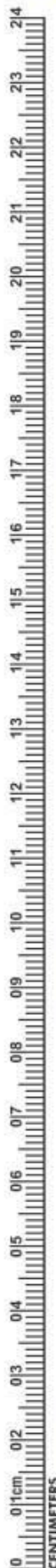

ROOT ELEVATOR



- Элеватор корневой экстракционный
- Elévateurs à racines
- Wurzelheber
- Слеватор корневий екстракційний
- Elevadores para raices
- المعاهد الجذر

Apical Root Elevators

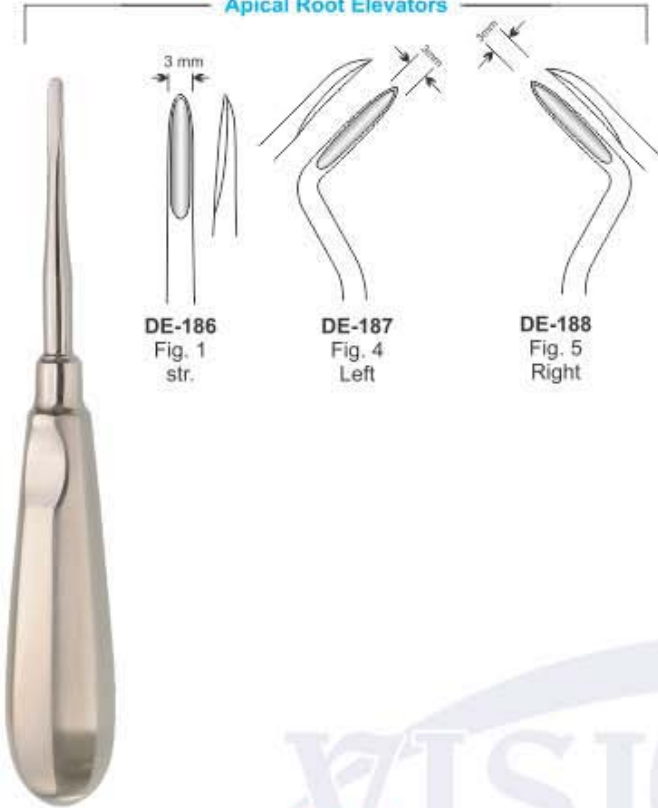

DE-186
Fig. 1
str.

DE-187
Fig. 4
Left

DE-188
Fig. 5
Right

Apical Root Elevators

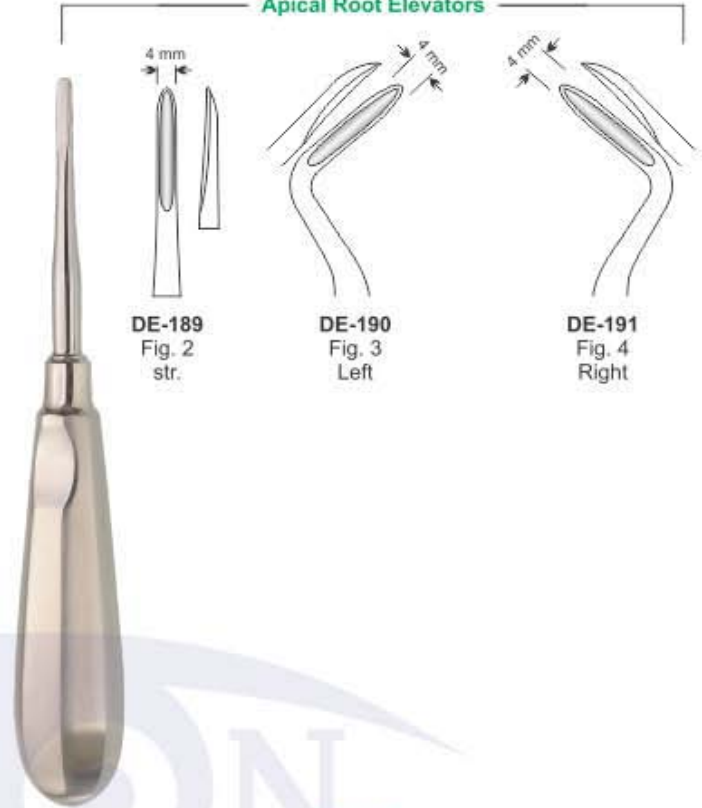

DE-189
Fig. 2
str.

DE-190
Fig. 3
Left

DE-191
Fig. 4
Right

Coupland Root Elevators

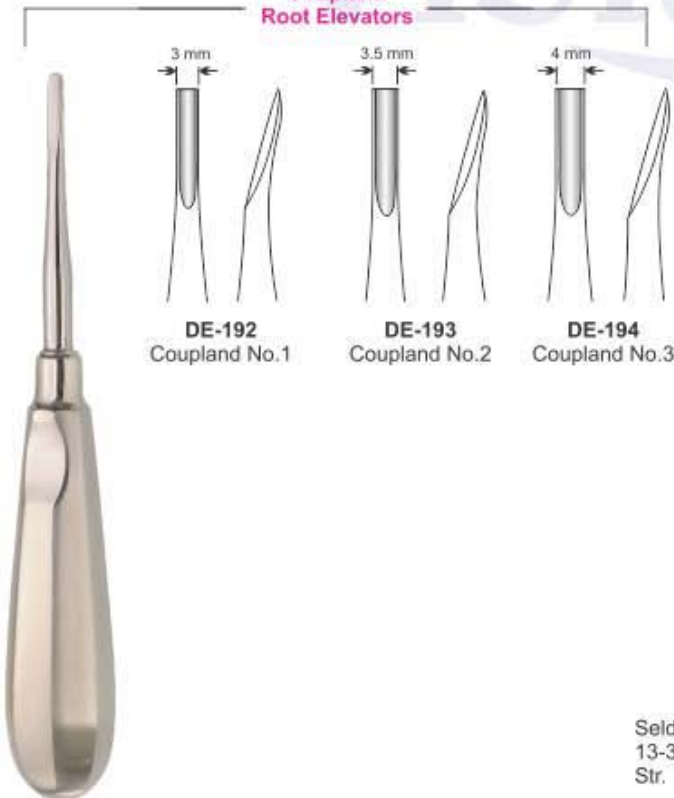

DE-192
Coupland No.1

DE-193
Coupland No.2

DE-194
Coupland No.3

Seldin Root Elevators

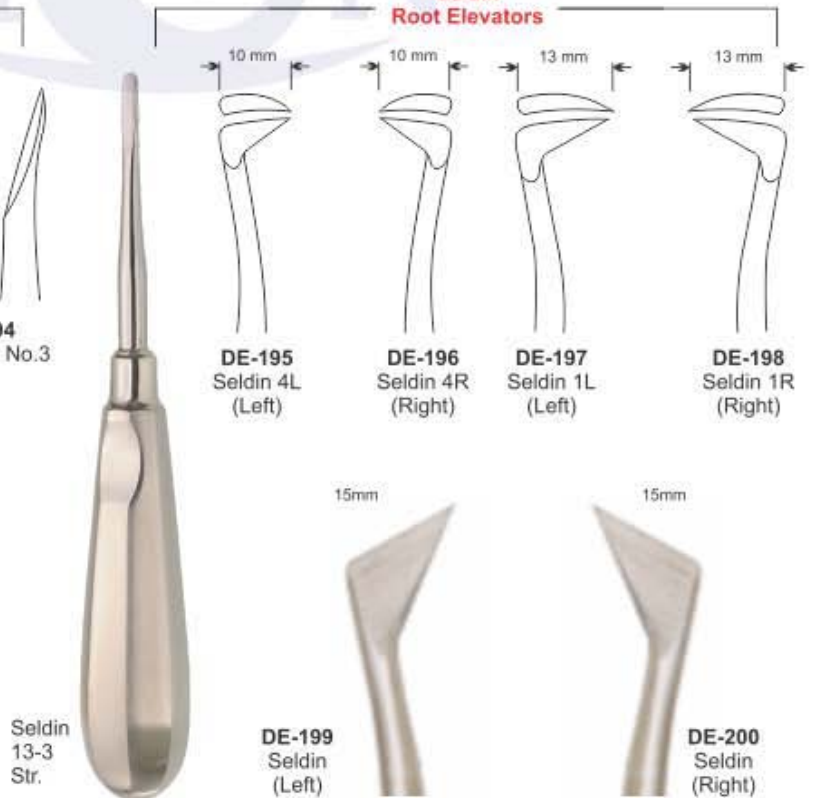

DE-195
Seldin 4L
(Left)

DE-196
Seldin 4R
(Right)

DE-197
Seldin 1L
(Left)

DE-198
Seldin 1R
(Right)

Seldin
13-3
Str.

DE-199
Seldin
(Left)

DE-200
Seldin
(Right)



- Элеватор корневой экстракционный
- Elévateurs à racines
- Wurzelheber

- Elevator cornevil ekstraktsionnyy
- Elevadores para raices
- المصاعد الجذر

Apical Root Elevators

Apical Root Elevators



DE-201
Fig. 1
Str.



DE-202
Fig. 4
Left



DE-203
Fig. 5
Right



DE-204
Fig. 2
Str.



DE-205
Fig. 3
Left

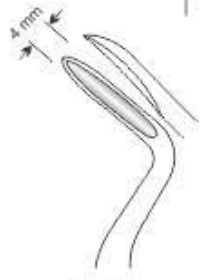

DE-206
Fig. 4
Right



Coupland Root Elevators

Seldin Root Elevators



DE-207
Coupland No.1



DE-208
Coupland No.2

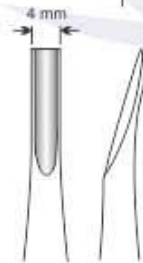

DE-209
Coupland No.3



DE-210
Seldin 4L
(Left)



DE-211
Seldin 4R
(Right)



DE-212
Seldin 1L
(Left)



DE-213
Seldin 1R
(Right)



Coupland



Seldin
13-3
Str.



DE-2
Seld
(Lef)



DE-215
Seldin
(Right)

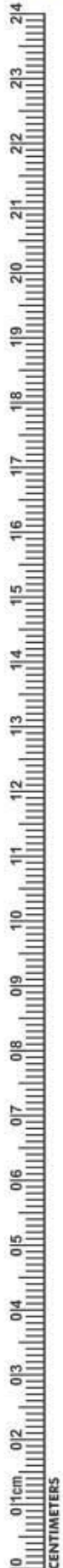

ROOT ELEVATOR



- Элеватор корневой экстракционный
- Elévateurs à racines
- Wurzelheber
- Elevator corneviu extracționii
- Elevadores para raices
- المعاصر الجذر

Apical Root Elevators



Apical Root Elevators



Apical Root Elevators



Laxutor Root Elevators



- Элеватор корневой экстракционный
- Elévateurs à racines
- Wurzelheber

- Elevator cornevil extraktsionniy
- Elevadores para raices
- المصاعد الجذر

Lindo Levian Root Elevators



Flohr Root Elevators

Heidbrink Root Elevators



ROOT ELEVATOR



- Элеватор корневой экстракционный
- Elévateurs à racines
- Wurzelheber
- Слеватор корневий екстракційний
- Elevadores para raices
- المعاعد الجذر

Friedmann Roots Elevator



DE-251 Friedmann 4F Str.
DE-252 Friedmann 5F Left
DE-253 Friedmann 6F Right

Heidbrink Roots Elevator



DE-254 Heidbrink Straight
DE-255 Heidbrink Left
DE-256 Heidbrink Right

Wisdom Roots Elevator



DE-257 Wisdom for 18 and 38
DE-258 Wisdom for 28 and 48

Bayonet Roots Elevator Set



DE-259 Left
DE-260 Right
DE-261 bayonet
DE-262 Curved
DE-263 Straight

Luxator Roots Elevator



DE-264 Luxator Straight
DE-265 Luxator Curved



- Элеватор корневой экстракционный
- Elévateurs à racines
- Wurzelheber
- Elevator corneviy ekstraktsionniy
- Elevadores para raices
- المصاعد الجذر

Roots Elevator



Luxier Roots Elevator



Luxier Roots Elevator



Claw-Lift Roots Elevator



ROOT ELEVATOR



- Элеватор корневой экстракционный
- Elévateurs à racines
- Wurzelheber
- Elevator cornevei extracționii
- Elevadores para raíces
- المعاعد الجذر

Hylin Roots Elevator

Cryer Roots Elevator



Kopp Roots Elevator



- Элеватор корневой экстракционный
- Élévateurs à racines
- Wurzelheber

- Єлеватор корневий екстракційний
- Elevadores para raices
- المصاعد الجذر

Kopp Roots Elevator



DE-295
Kopp
Right

DE-296
Kopp
Left

Heber Roots Elevator



DE-297
Heber
Bayonet

DE-298
Heber
Bayonet

Bein Roots Elevator



DE-299
Bein,
3mm

DE-300
Bein,
4mm

Bein Roots Elevator



DE-301
Bein
2mm, curved
serrated

DE-302
2mm
straight
serrated

DE-303
3mm
straight

DE-304
4mm
Curved



DE-305
Bein
2mm, curved
serrated

DE-306
2mm
straight
serrated

DE-307
3mm
straight

DE-308
4mm
Curved



DE-309
Bein
2mm, curved
serrated

DE-310
2mm
straight
serrated

DE-311
3mm
straight

DE-312
4mm
Curved

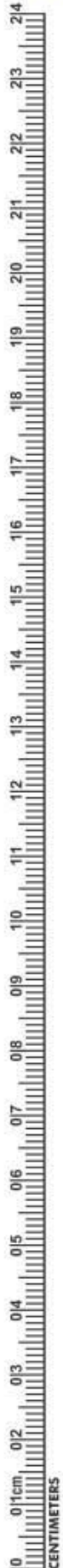

ROOT ELEVATOR



- Элеватор корневой экстракционный
- Elévateurs à racines
- Wurzelheber
- Elevator cornevei extrакційний
- Elevadores para raices
- المصاعد الجذر

Seldin Roots Elevator



W. Barry Roots Elevator



Winter Roots Elevator



Pott Roots Elevator



- Элеватор корневой экстракционный
- Elévateurs à racines
- Wurzelheber

- Elevator corneveiey ekstraktsionnyiy
- Elevadores para raices
- المصاعد الجذر

Heidbrink Roots Elevator



DE-338 Heidbrink Straight
 DE-339 Heidbrink Left
 DE-340 Heidbrink Right
 DE-341 Heidbrink Straight
 DE-342 Heidbrink Left
 DE-343 Heidbrink Right

Syndesmotomes Roots Elevator



DE-344 Straight
 DE-345 Left
 DE-346 Right

Periotome Roots Elevator



DE-347 Periotome 2.1mm Straight
 DE-348 Periotome 2.6mm Straight
 DE-349 Periotome 2.1mm Angular
 DE-350 Periotome 2mm Curved
 DE-351 Periotome 2.0mm
 DE-352 Periotome 2.5mm
 DE-353 Periotome 3.0mm
 DE-354 Periotome 4.0mm

Syndesmotomes



ROOT ELEVATOR



- Элеватор корневой экстракционный
- Elévateurs à racines
- Wurzelheber
- Слеватор корневий екстракційний
- Elevadores para raices
- المصاعد الجذر



DE-355
1S
(Straight 1mm)



DE-356
2S
(Straight 2mm)



DE-357
3S
(Straight 3mm)



DE-358
5S
(Straight 5mm)



DE-359
3C
(Curved 3mm)



DE-360
5C
(Curved 5mm)



DE-361
3CA
(Curved Angle 3mm)



DE-362
3IC
(Inverted Curved 3mm)



DE-363
DE 3
(Dual Edge 3mm / 1.5mm)



DE-364
DE 5
(Dual Edge 5mm / 3mm)



- Элеватор корневой экстракционный
 - **Élévateurs à racines**
 - Wurzelheber
- PDL ELEVATORS**

- Елеватор корневий екстракційний
- Elevadores para raices
- المصاعد الجذر

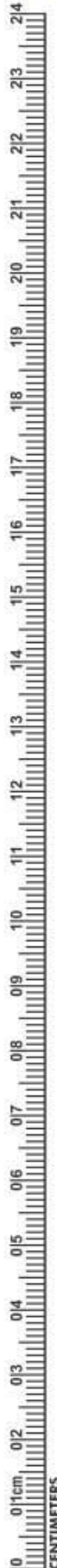

Distal, 2.5mm
Micro Edge

Mesial, 2.5mm
Micro Edge

Distal, 4mm
Micro Edge

Mesial, 4mm
Micro Edge

2.5mm
Micro Edge, curved

2.5mm
Micro Edge, Straight

3.4mm
Straight

DE-365
PDL Elevators
Set of 7 Pcs

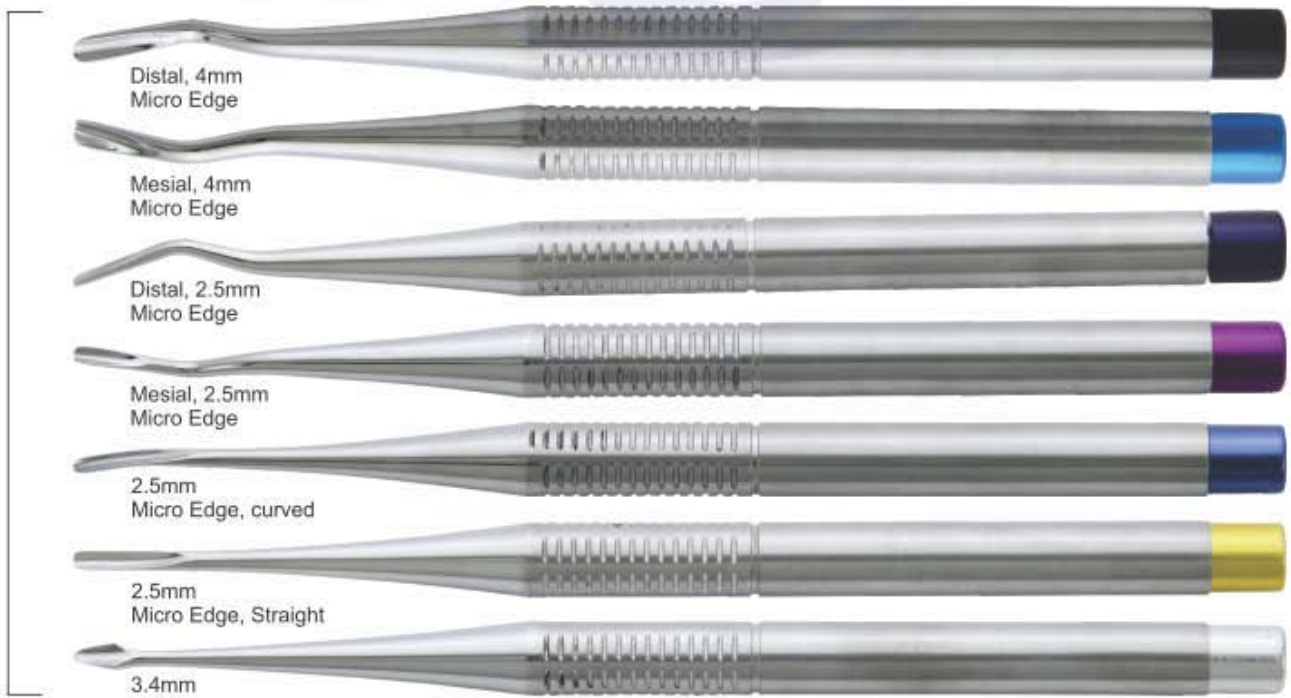

Distal, 4mm
Micro Edge

Mesial, 4mm
Micro Edge

Distal, 2.5mm
Micro Edge

Mesial, 2.5mm
Micro Edge

2.5mm
Micro Edge, curved

2.5mm
Micro Edge, Straight

3.4mm
Straight

DE-366
PDL Elevators
Set of 7 Pcs

ROOT ELEVATOR



- Элеватор корневой экстракционный
- Elévateurs à racines
- Wurzelheber
- Слеватор корневий екстракційний
- Elevadores para raices
- المعاعد الجذر

PDL ELEVATORS

Delicate Arrow tip



4,0mm straight
4,0mm curved

Luxivators straight
atraumatic luxation of the tooth



2,5mm straight
3,5mm straight
4,5mm straight

Luxivators curved
atraumatic luxation of the tooth



2,5mm curved
3,5mm curved
4,5mm curved



DE-367
PDL Elevators
Set of 8 Pcs



Our Scalers

Compare our scalers and curettes with the best in the industry and you will immediately recognize we are equal in every way but one... price. Note the deep precision knurling for better tactile feel. The same high-grade stainless steel tips, the same light weight (under 18 grams) for less hand fatigue, the same professional craftsmanship, and surpassing the highest industry standards. of course, any manufacturer can make these claims, but we guarantee and certify ours.

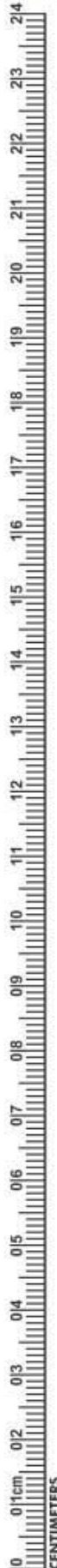

Healthy

Periodontal Disease

Healthy Gums

Healthy Attachment and Bone Levels

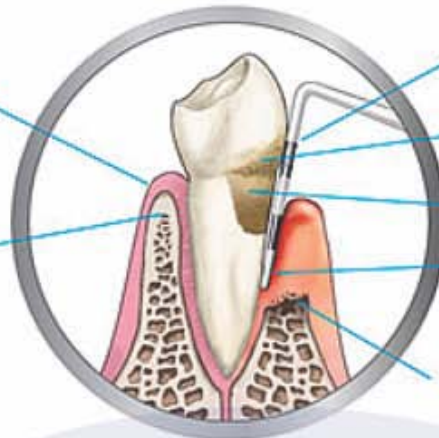

Periodontal Prob

Plaque Bacteria Biofilm

Calculus / Tartar

Periodontal Pocke

Reduced Attachmen and Bone Level



- Biocubic, beveled flange on corner bar
- Deep cross-cut, knurling for better manual control
- Titanium coated wire to protect the blood stream
- CNC machined for excellent balance, precision and consistency
- 2.0mm diameter for easier handling and better tactile sensitivity
- Boder knurled throughout the day
- Evenly balanced for consistent control when switching from tip to tip
- 120 mm length of handles without tips

- High-polish mirror finish tips.
- Manufactured within the guidelines of the FDA quality assurance system for good manufacturing practices.
- Highest grade German stainless steel, razor sharp, durable tips. Rockwell hardened to 60 RHc.
- 27 of the most popular designs from graceys to McCalls to cumbias, and many european patterns.
- All instruments are guaranteed against defects in material and workmanship.

- All instruments bear the ce mark, emblematic of the european community's highest standards.
- Customer satisfaction guarantee, too!
- Less than 20 grams ... Lightweight for less hand fatigue.
- Manufactured to the most exacting standards so the 50th instrument you buy is exactly like your first.
- You decide ... Why pay more for the same high-quality instruments?

HANDLES FOR MOUTH MIRRORS



- Ручки для зеркал
- Manches pour miroirs à bouche
- Mundspiegelgriffe
- Ручки для дзеркал
- Mangos para espejos de boca
- مقابض لمرآيا الفم



Magnifying

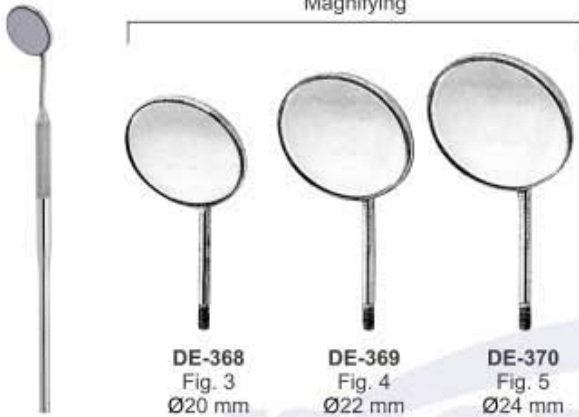

Plain

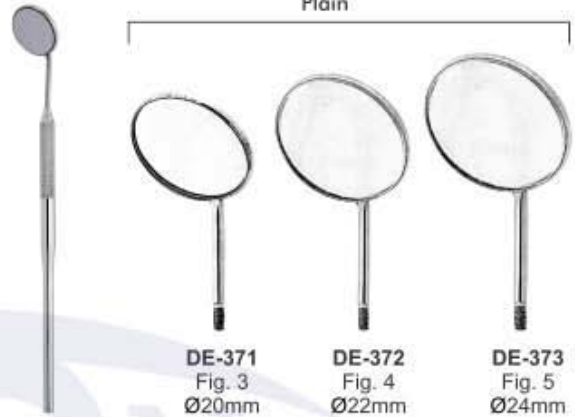

Rhodium

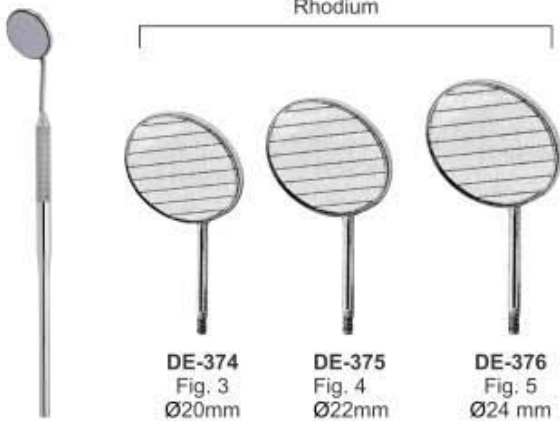

- Пинцеты
- Précelles - Brucelles
- Zahnpinzetten

- Пинцети
- Pinzas para algodón
- مكافف



DE-381
Surgical
11.5cm



DE-382
London College
15cm



DE-383
Semken Taylor
Str.



DE-384
Semken Taylor
Cvd.



DE-385
Meriam
16cm



DE-386
Dressing
14cm



DE-387
Semken Taylor
1x2 Straight



DE-388
Semken Taylor
1x2 Curved



DE-389
Gilles
15cm 1x2



DE-390
14cm 1x2



DE-391
Perry
13cm



DE-392
Atraumatic
15cm Cvd



DE-393
Atraumatic
15cm Str.



DE-394
College with Lock
15cm Cvd.



DE-395
Gerald
17.5cm



DE-396
with lock
15cm



DE-397
Atraumatic
17.5cm

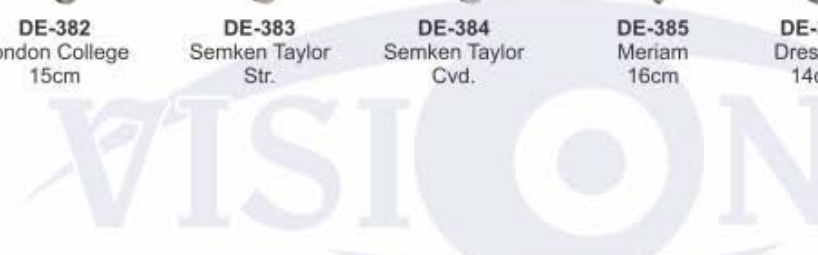

TWEEZERS



- Пинцеты
- Prêcelles - Brucelles
- Zahnpinzetten

- Пинцети
- Pinzas para algodón
- ملاقط



DE-398
Adson-TC
12cm



DE-399
Adson-TC
12cm 1x2



DE-400
Adson-TC
15cm 1x2



DE-401
Adson
12cm



DE-402
Adson
12cm 1x2



DE-403
Adson
15cm 1x2



DE-404
Adson Brown
12cm



DE-405
Crane Kaplan
15cm



DE-406
Crane Kaplan
15cm



DE-407
Crane Kaplan
15cm



DE-408
Hemingway
15cm



DE-409
Miller
15cm Str.



DE-410
Miller
15cm Cvd.



DE-411
Dressing
Tweezer
14.5cm



DE-412
College
Curved
Tip 15cm



DE-413
Maryam
Tweezers
15cm



DE-414
College
Tweezer
15cm



DE-415
Perry
Tweezer
12.5cm



DE-416
Self-locking
Tweezer
15cm



- Зонды
- Sondes
- Zahnsonden
- Зонди
- Sondas
- المستكشفين

Single Ended Probe Solid Handle 4.5mm Length 150mm

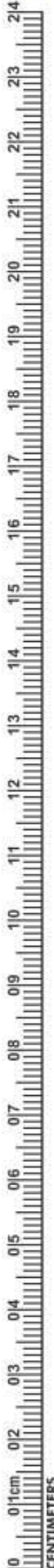
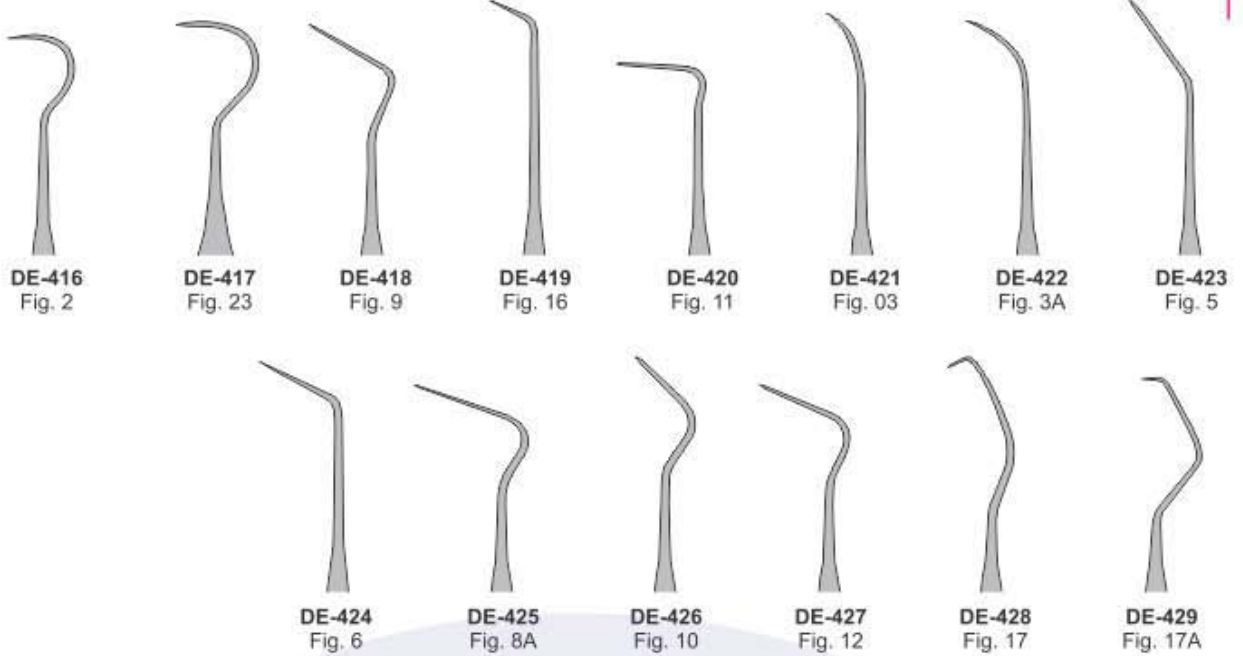

Fig. 2
Normal Handle



Single Ended Probe Hollow Handle 8.5mm Length 150mm



Fig. 2
Anatomic Handle

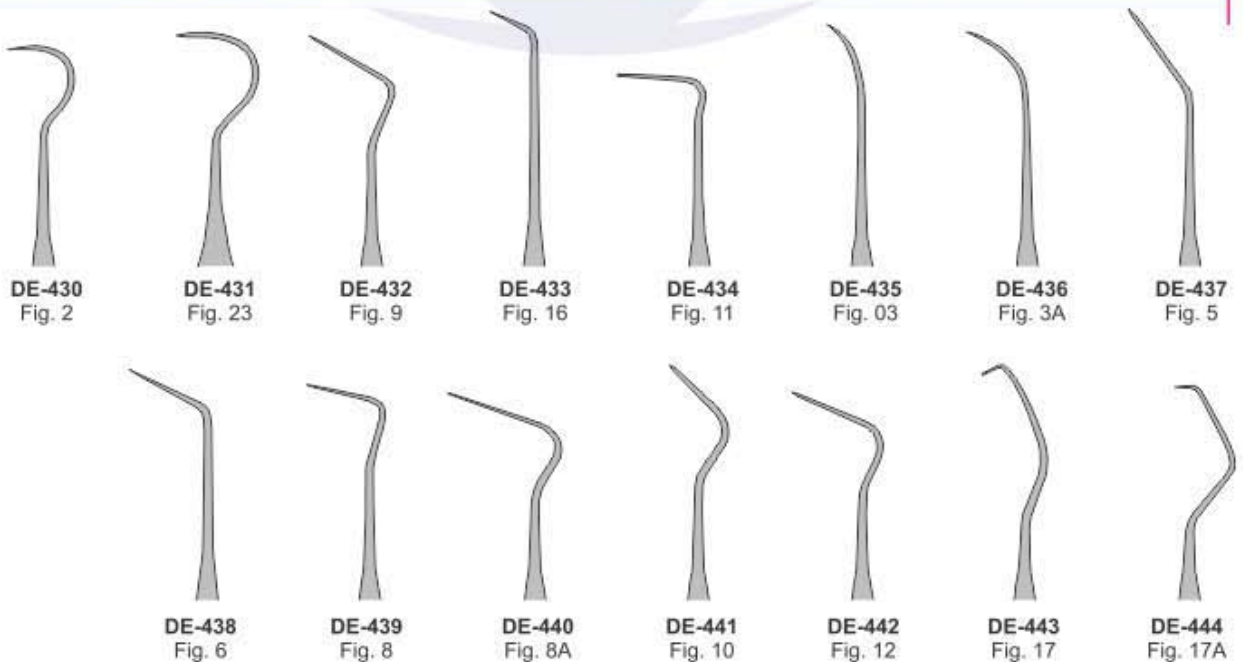

EXPLORERS



- Зонды
- Sondes
- Zahnsonden
- Зонди
- Sondas
- المستكشفين

Probes Single End Solid Handle 6mm, length 150mm

Probes Single Ended 6mm, length 150mm



DE-445
Fig. 6

DE-446
Fig. 8

DE-447
Fig. 9

DE-448
Fig. 16

DE-449
Fig. 23

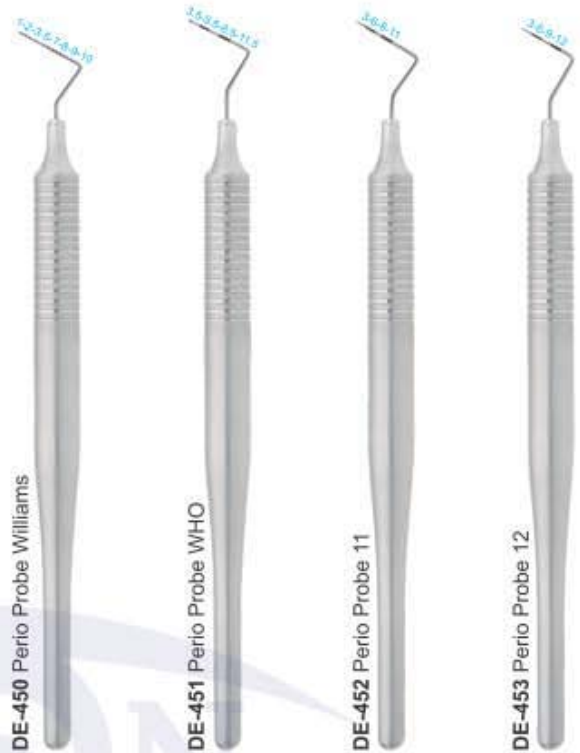

DE-450 Perio Probe Williams

DE-451 Perio Probe WHO

DE-452 Perio Probe 11

DE-453 Perio Probe 12

Examination kit Set of 3 Pieces

Examination Set of 4 Pieces

Examination Set of 4 Pieces



DE-454
Probe

DE-455
Mirror

DE-456
College Forcep
15cm



DE-457
Exp.23/17-A

DE-458
Exavators

DE-459
Tweezers

DE-460
Mouth Mirror



EXPLORERS INSTRUMENTS SOLID HANDLE 6MM, LENGTH 170MM

- Зонды
 - Sondes
 - Zahnsonden
- Зонди
 - Sondas
 - المستكشفين

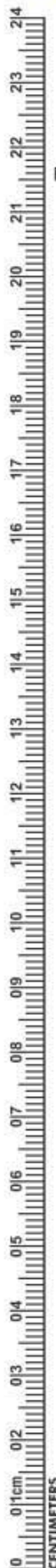

Explorers-Single-End

Double-Ended Explorers

EXPLORERS

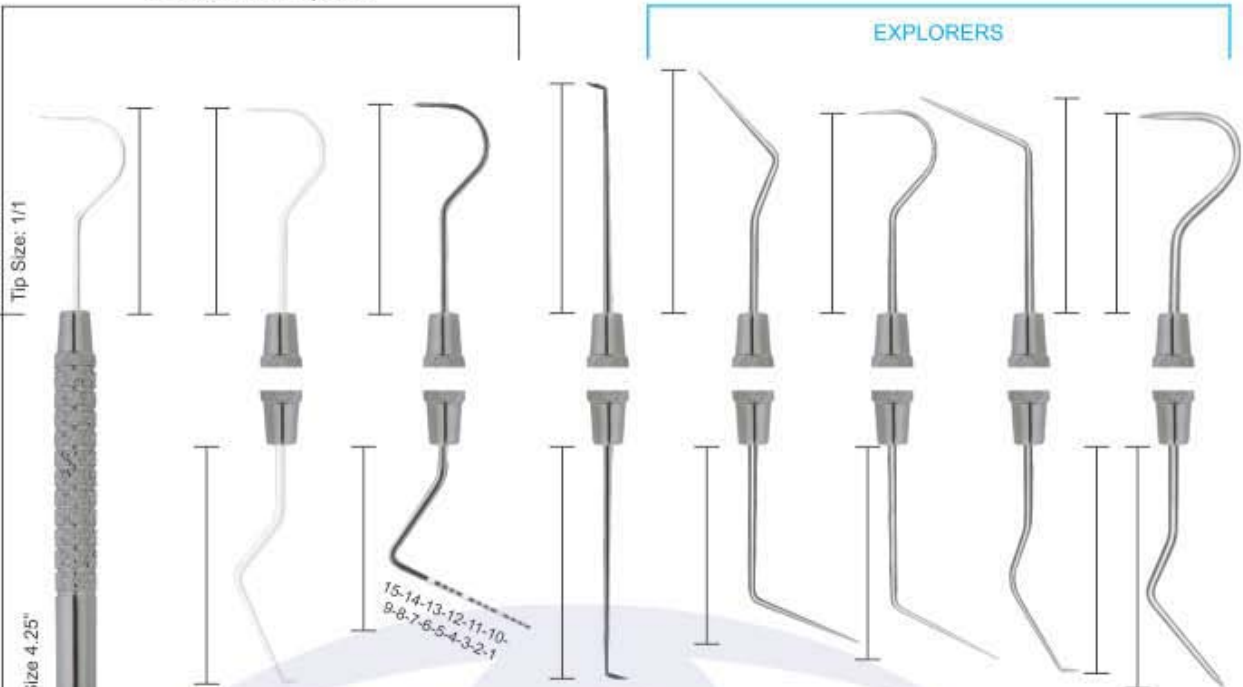

DE-463
TU 17/23
Wilkins/Tufts
Explorer
#6

DE-464
23/UNC1
university of north
carolina
Explorer #31, #6, #7, #8

DE-465
1
#31, #6

DE-466
DG 16
#31, #6, #7
Thick, #6

DE-467
DG 16/23

DE-468
DG 16/17

DE-469
1
Abou-Rass
Explorers

Probes Double Ended 6mm, length 170mm



DE-470
Goldman Fox
Fig.17

DE-471
University
of Michigan
Fig.17

DE-472
Williams
Fig.17

DE-473
Goldman Fox
Fig.16

DE-474
University
of Michigan
Fig.16

DE-475
Williams
Fig.16

DE-461
23
Shepherd's
Hook
Explorer
#30, #6, #7, #8

DE-462
#5, #6
Explorer

EXPLORERS



- Зонды
- Sondes
- Zahnsonden
- Зонди
- Sondas
- المستكشفين

Pointed Probes Single Ended Handle 6mm, length 150mm

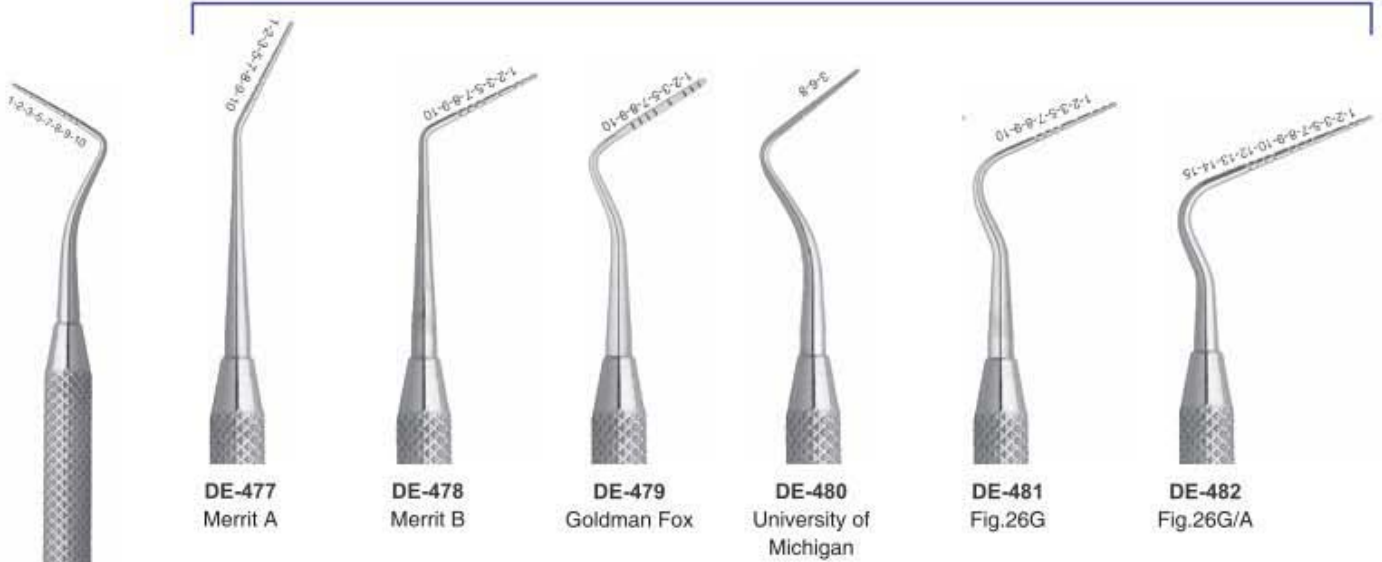

Pointed Probes Double Ended Handle 6mm, length 170mm



- Инструменты пародонтологические
- Instruments pour la parodontologie
- Instrumente für die Parodontologie
- Инструменти пародонтологічні
- instrumentos para periodoncia
- الصكوك اللثة

PERIODONTAL SET OF 10 PIECES SOLID HANDLE 6MM LENGTH 170MM

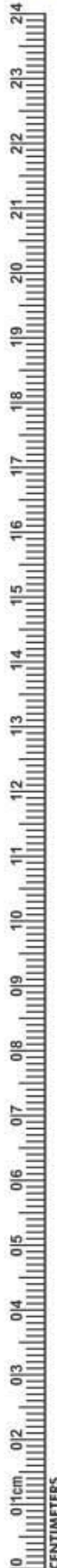

DE-488 MOUTH MIRROR

DE-489 EXP,23/17-A

DE-490 EXAVATORS

DE-491 Filling Instruments

DE-492 EXP,23/CP-18

DE-493 EXP,23/CP-QW

DE-494 EXP,23/CP-11

DE-495 EXP,23/CP-10

DE-496 EXP,23/CP-12

DE-497 EXP,23/CP-11.5-B

EXPLORERS



- Зонды
- Sondes
- Zahnsonden
- Зонди
- Sondas
- المستكشفين

WILLIAM PROBE SET DOUBLE ENDED WITH HOLLOW HANDLE 9.5MM, LENGTH 170MM
CERAMIC COATED HANDLE

Proper care must be given during cleaning, sharpening and sterilization to preserve design and integrity and to prolong usefulness. Do not expose instruments to sterilization temperatures above 350 F/177 C or to higher than recommended chemical concentrations.

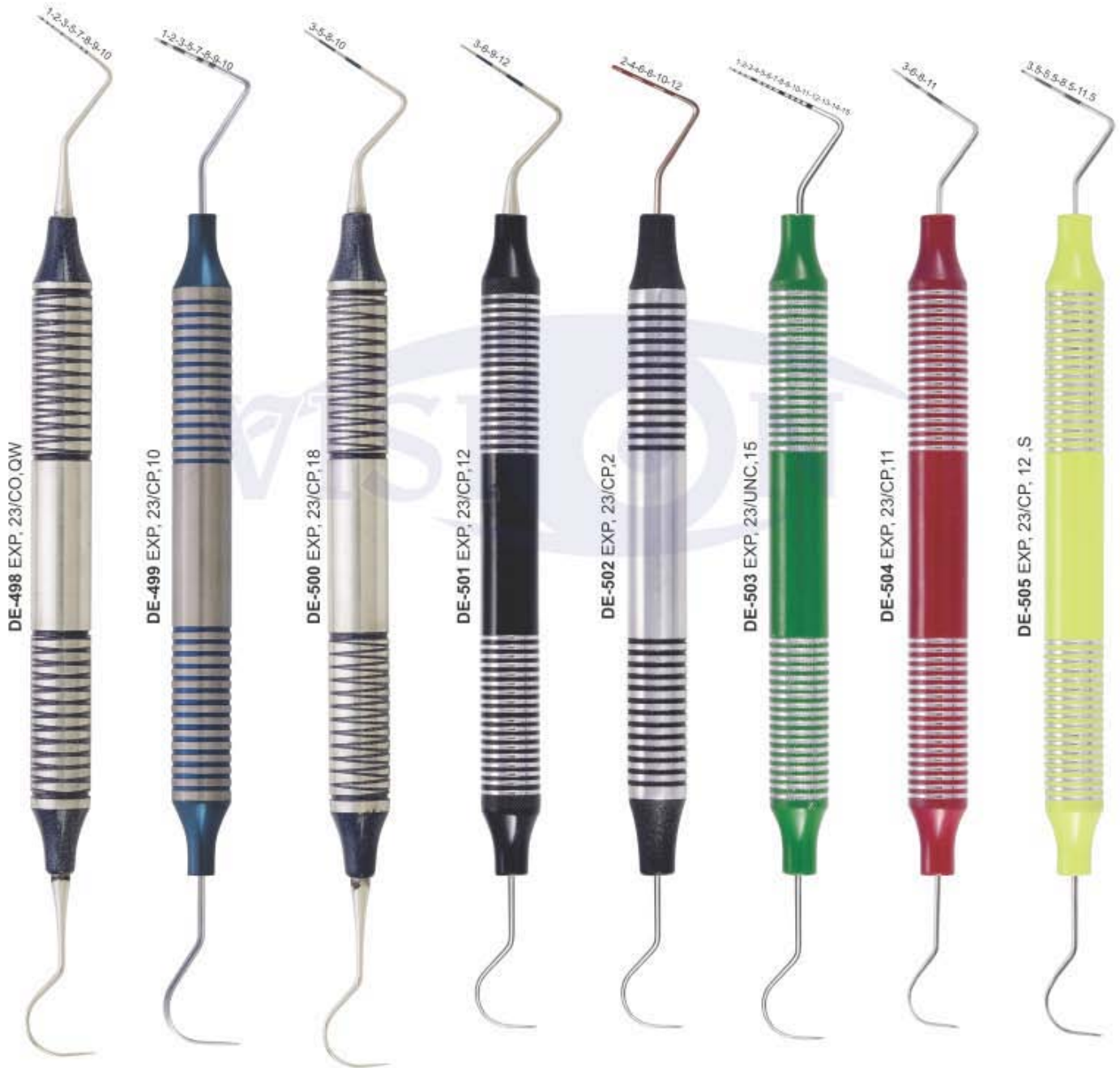

- Инструменты пародонтологические
- Instruments pour la parodontologie
- Instrumente für die Parodontologie

- Інструменти пародонтологічні
- instrumentos para periodoncia
- الصكوك اللثة

**PERIODONTAL INSTRUMENTS SET OF 11 PCS
SOLID HANDLE 6MM, LENGTH 170MM**

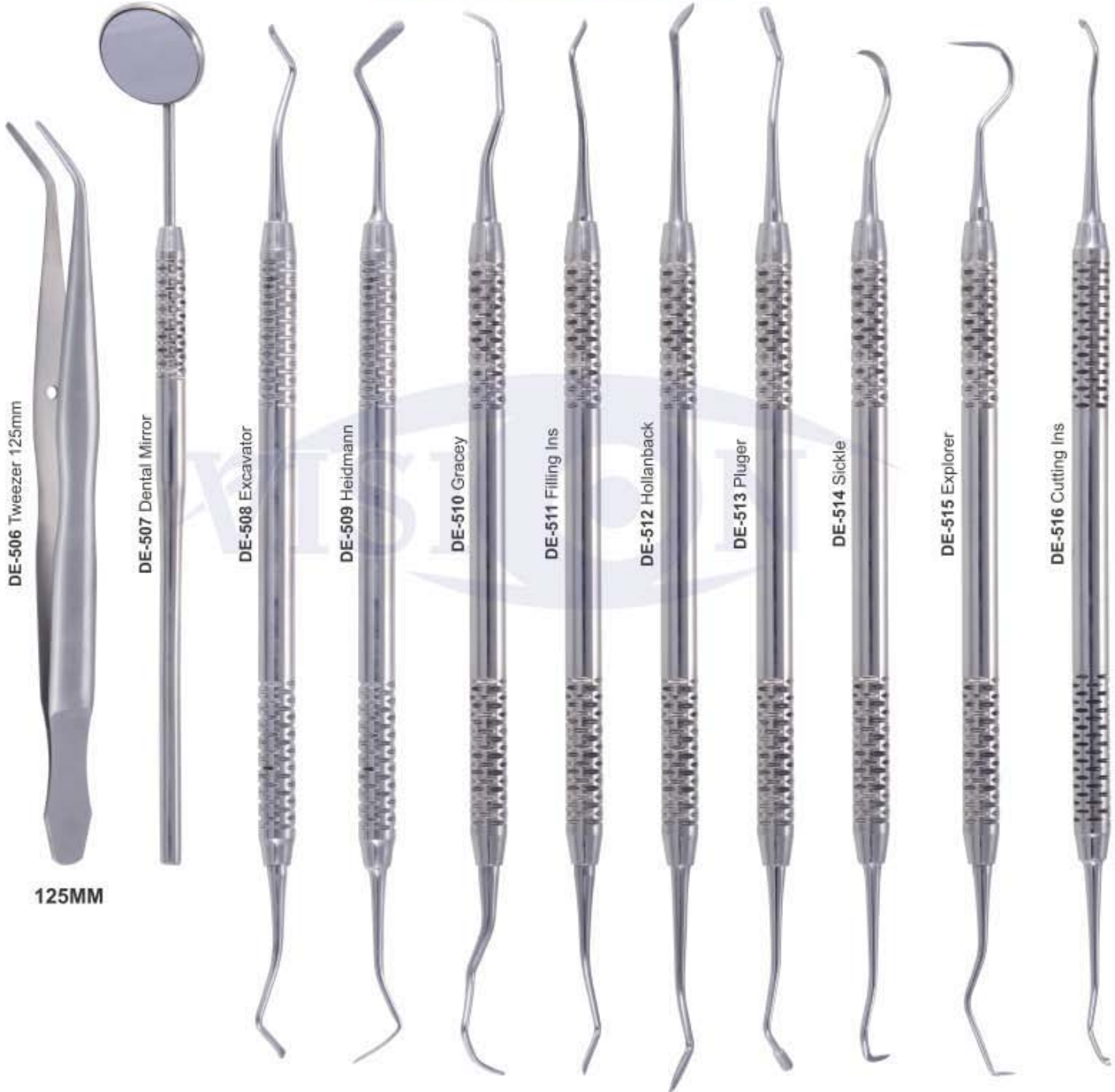
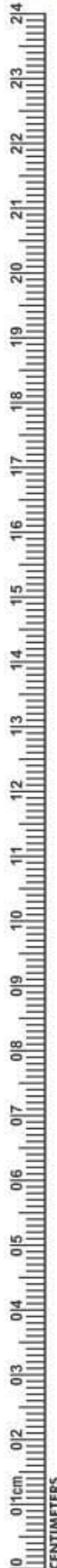

125MM

CURETTES



- Кюрети
- Curetas
- Küretten
- Кюрети
- Curette
- كرتس

GRACEY SET OF 7 PCS HOLLOW HANDLE 9.5MM, LENGTH 170MM



DE-517
GRACEY
1/2

DE-518
GRACEY
3/4

DE-519
GRACEY
5/6

DE-520
GRACEY
7/8

DE-521
GRACEY
9/10

DE-522
GRACEY
11/12

DE-523
GRACEY
13/14



- Кюрети
 - Curetas
 - Kuretten
- Кюрети
 - Curette
 - کرتس

GRACEY SET OF 7 PCS
HOLLOW HANDLE 9.5MM, LENGTH 170MM WITH SILICON GRIP

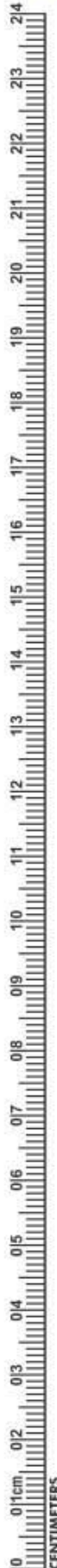

DE-524
GRACEY
1/2

DE-525
GRACEY
3/4

DE-526
GRACEY
5/6

DE-527
GRACEY
7/8

DE-528
GRACEY
9/10

DE-529
GRACEY
11/12

DE-530
GRACEY
13/14

CURETTES



- Кюрети
- Curetas
- Küretten
- Кюрети
- Curette
- کرتس

GRACEY MINI FIVE

HOLLOW HANDLE 9.5MM, LENGTH 170MM
CERAMIC COATED HANDLE



DE-531 Gracey 1/2
DE-532 Gracey 3/4
DE-533 Gracey 5/6
DE-534 Gracey 7/8
DE-535 Gracey 11/12
DE-536 Gracey 13/14

GRACEY AFTER FIVE

HOLLOW HANDLE 9.5MM, LENGTH 170MM
CERAMIC COATED HANDLE

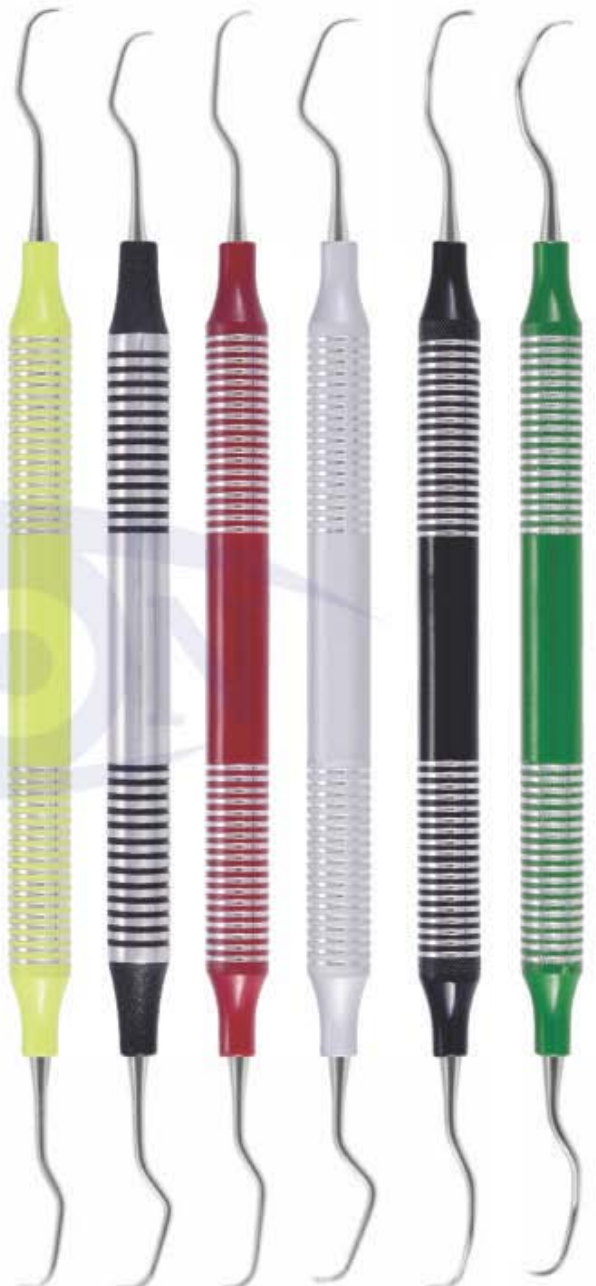

DE-537 Gracey 1/2 AF
DE-538 Gracey 3/4 AF
DE-539 Gracey 5/6 AF
DE-540 Gracey 7/8 AF
DE-541 Gracey 11/12 AF
DE-542 Gracey 13/14 AF

Proper care must be given during cleaning, sharpening and sterilization to preserve design and integrity and to prolong usefulness. Do not expose instruments to sterilization temperatures above 350 F/177 C or to higher than recommended chemical concentrations.



- Кюрети
- Curetas
- Kuretten
- Кюрети
- Curette
- کرتس

**GRACEY CURETTE
HOLLOW HANDLE 10MM, LENGTH 170MM**

Curetters Set of 8 Pieces



DE-543
Curette
Columbia
2L-2R

DE-544
Curette
Columbia
4L-4R

DE-545
Curette
McCall
13S-14S

DE-546
H6-H7
Scaler
Sickle

DE-547
H5-U15
Scaler
Sickle

DE-548
H5-13
Scaler
Sickle

DE-549
U15-30
Scaler
Sickle

DE-550
U15-33
Scaler
Sickle

FILLING INSTRUMENTS



- Инструменты для реставрации
- Instruments pour plombage
- Füllungsinstrumente (mit Kontrawinkel)
- Инструменти для реставрації
- Instrumentos para obturaciones
- ملء الصكوك

FILLING INSTRUMENTS (Gold Pointed)
SOLID HANDLE 6MM, LENGTH 170MM



Solid Handle Size 4.25"

Tip Size: 1/1

DE-551 1.5mm / 1.5mm

DE-552 2.0mm / 2.0mm

DE-553 2.0mm / 2.0mm

DE-554 2.5mm / 2.5mm

DE-555 1.3mm / 0.9mm

DE-556 1.6mm / 1.3mm

DE-557 2.4mm / 1.8mm

DE-558 2.4mm / 2.0mm

DE-559 1.3mm / 1.5mm

DE-560 1.8mm / 1.2mm

Filling instrument, spatula 6 mm solid handle, length 170 mm,

Filling instrument 6 mm length 175 mm,

Filling instrument, ball 6 mm length 170 mm,

Filling instrument, ball / spatula 6 mm length 175 mm,

Filling instrument, plan / plan 6 mm length 165 mm,

**EXPLORERS INSTRUMENTS
SOLID HANDLE 6MM, LENGTH 170MM**

- Зонды
 - Sondes
 - Zahnsonden
- Зонди
 - Sondas
 - المستكشفين

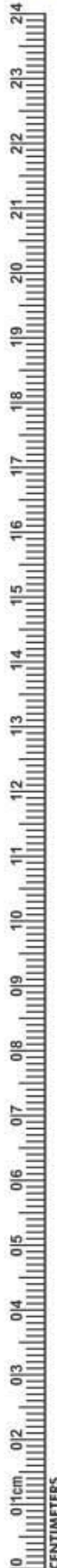

PLUGGERS

 .50 DE-562 5/7 21mm	 1.00 DE-563 9/11 21mm	 .50 DE-564 1/2 Root Canal Plugger	 .80 DE-565 3/4 Root Canal Plugger
 .45 DE-561 1/3 21mm	 .75 DE-566 MA57 27mm	 1.15 DE-567 GP3 30mm	 .60 DE-568 ISO Size 30 24mm
 .30 DE-569 ISO Size 40 24mm	 .40 DE-570 ISO Size 50 24mm	 .50 DE-571 ISO Size 60 24mm	 .20 DE-572 MA57 27mm
 .60 DE-573 GP3 30mm	 .25 DE-574 GP3 30mm		

PERIODONTAL PROBES



- Зонды пародонтологические
- Sondes paradontales
- sonde paradontali
- зонди пародонтологічні
- Sondas paradontales
- المسابر اللثة

SPREADERS

HEAT CARRIERS

Tip Size: 1/16
Solid Handle Size 4.25"

Model	ISO / Standard	Size	Length
DE-572	ISO	Size 30	24mm
DE-573	ISO	Size 40	24mm
DE-574	ISO	Size 50	28mm
DE-575	ISO	Size 60	28mm
DE-576	GP1	20mm	25
DE-577	1S Wakai	22mm	30
DE-578	2S Wakai	22mm	40
DE-579	D11 Standard	23mm	40
DE-580	D11S Thin	23mm	35
DE-581	D11T Thinner	22mm	23
DE-582	D11TS Thinnest	21mm	20
DE-583	3	28mm	35
DE-584	GP2	25mm	25
DE-585	0‡	25mm	35
DE-586	00‡	25mm	55

HEAT CARRIERS



- Зонды пародонтологические
 - Sondes paradontales
 - sonda parodontali
- зонди пародонтологічні
 - Sondas paradontales
 - المسابر اللثة

ENDODONTICS INSTRUMENTS

ANTERIOR

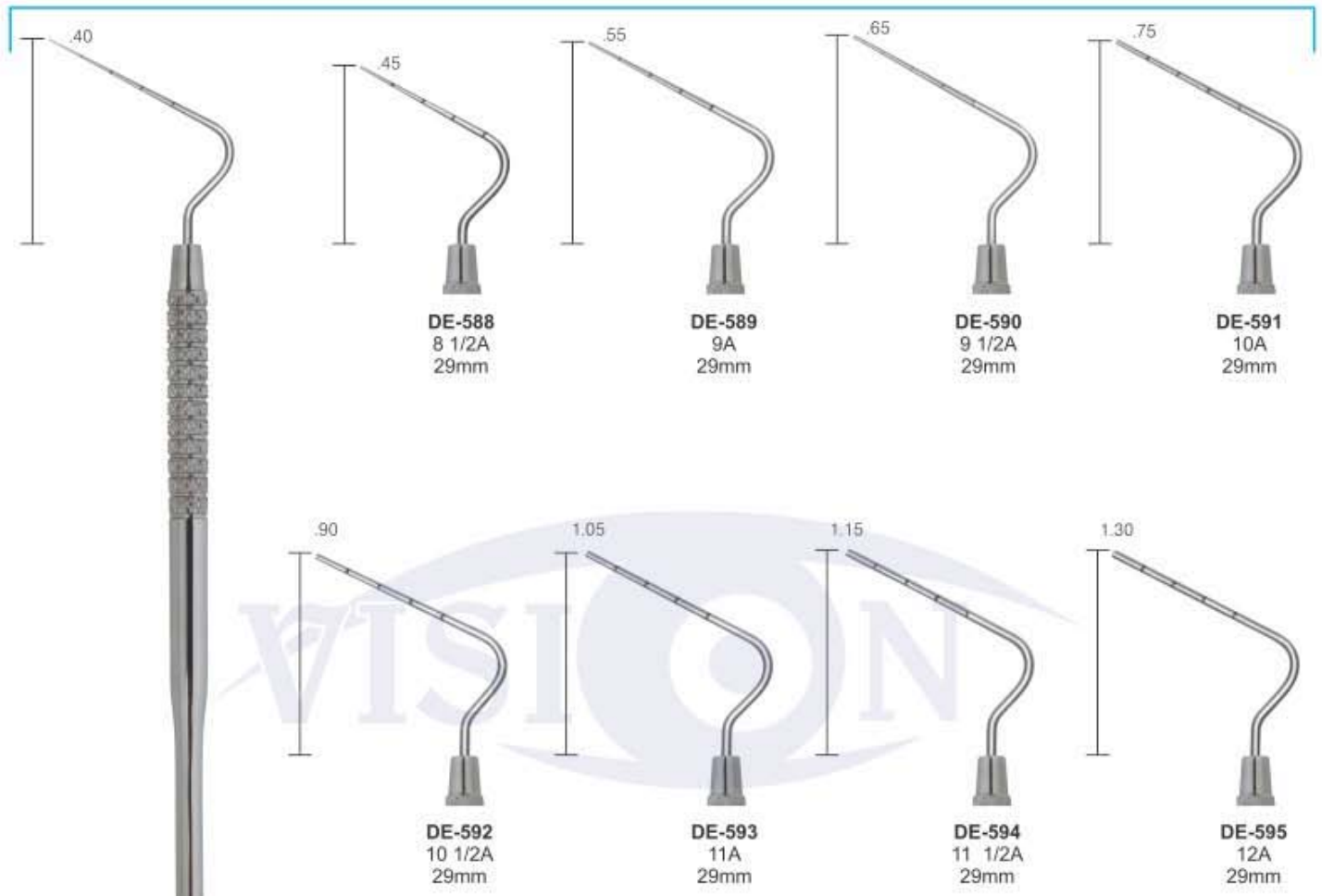

LUKS



DE-587
8A
29mm



PERIODONTAL PROBES



- Зонды пародонтологические
- Sondes paradontales
- sonda paradontali
- зонди пародонтологічні
- Sondas paradontales
- المسابر اللثة

ENDODONTICS INSTRUMENTS SOLID HANDLE 6MM, LENGTH 170MM

POSTERIOR



RETRO FILLING PLUGGERS

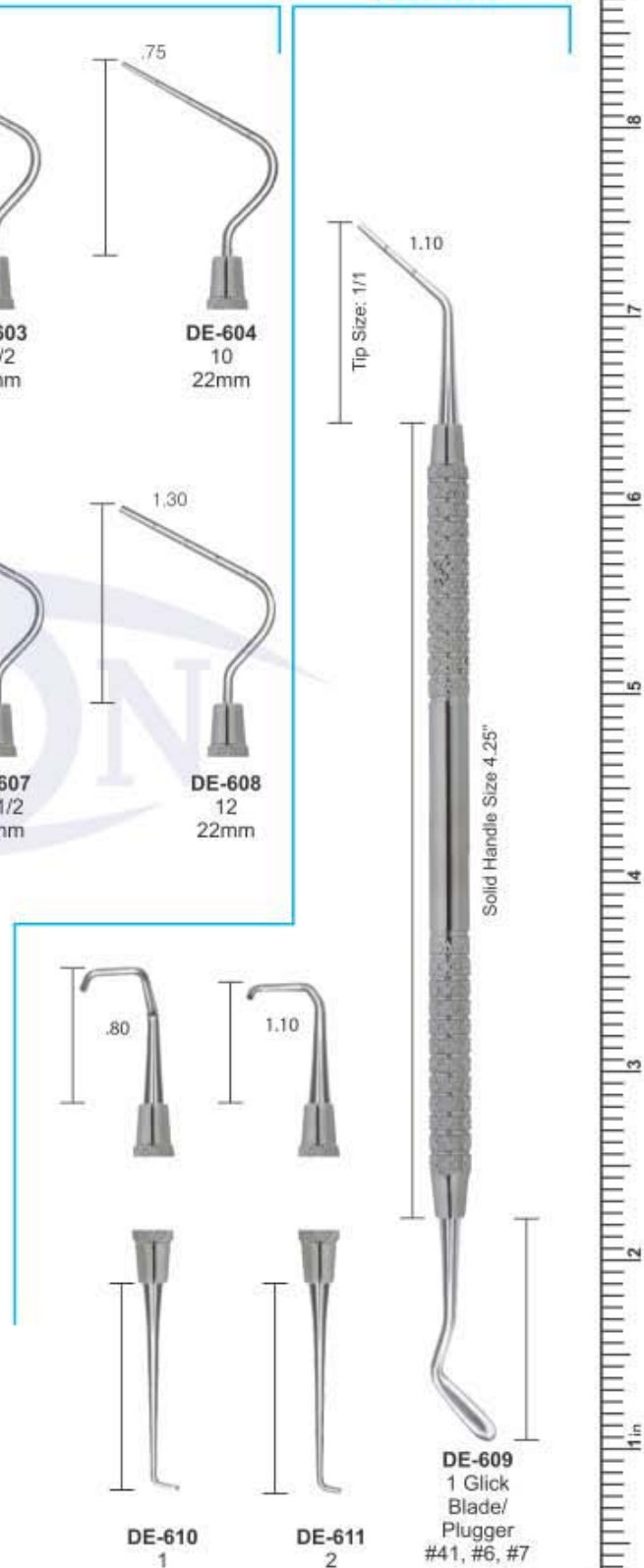

- Инструменты для реставрации
- Instruments pour plombage
- Füllungsinstrumente (mit Kontrawinkel)

- Инструменти для реставрації
- Instrumentos para obturaciones
- ملء الصكوك

COMPOSITE/PLASTIC FILLING INSTRUMENTS SOLID HANDLE 6MM, LENGTH 170MM

POSTERIOR

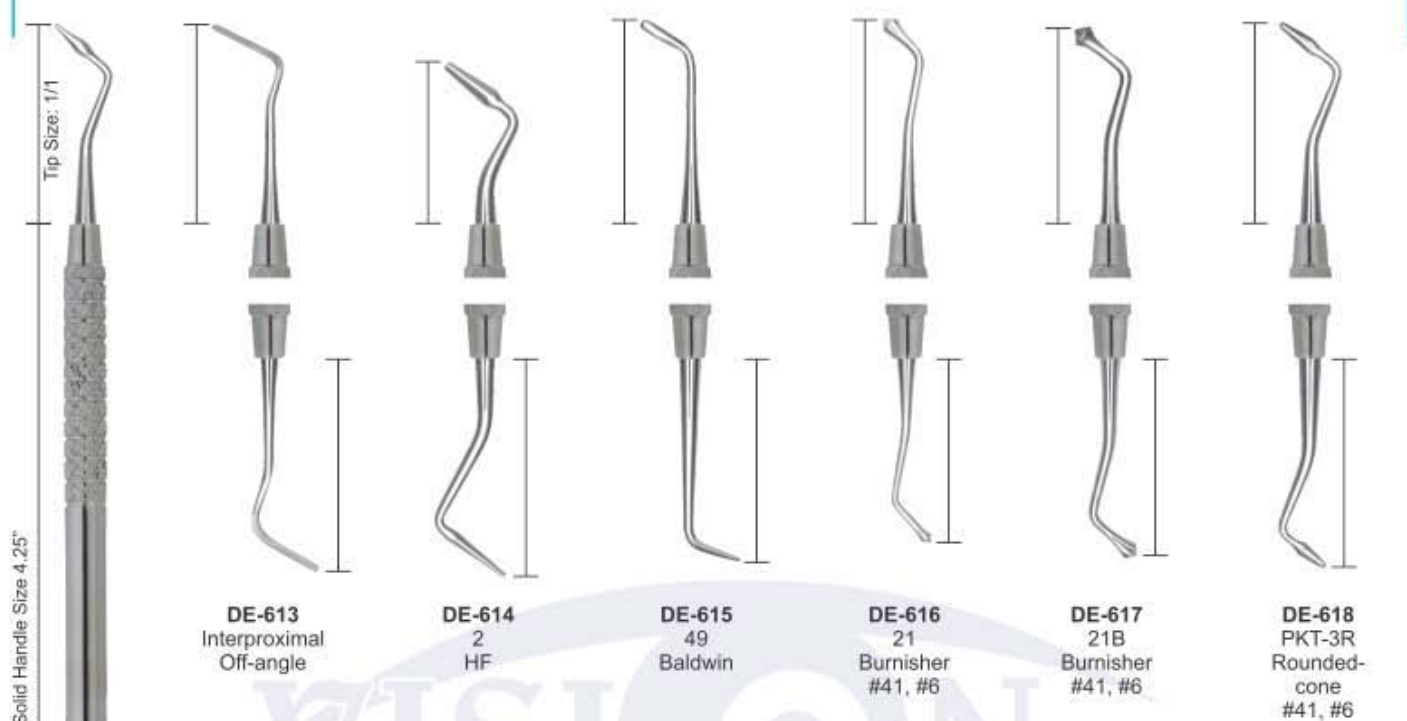
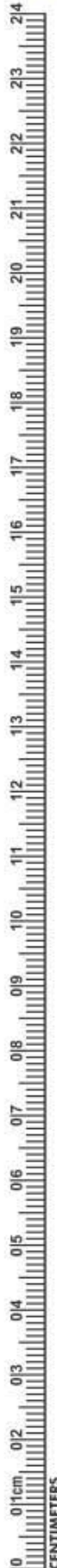

UNIVERSAL FILLING INSTRUMENTS

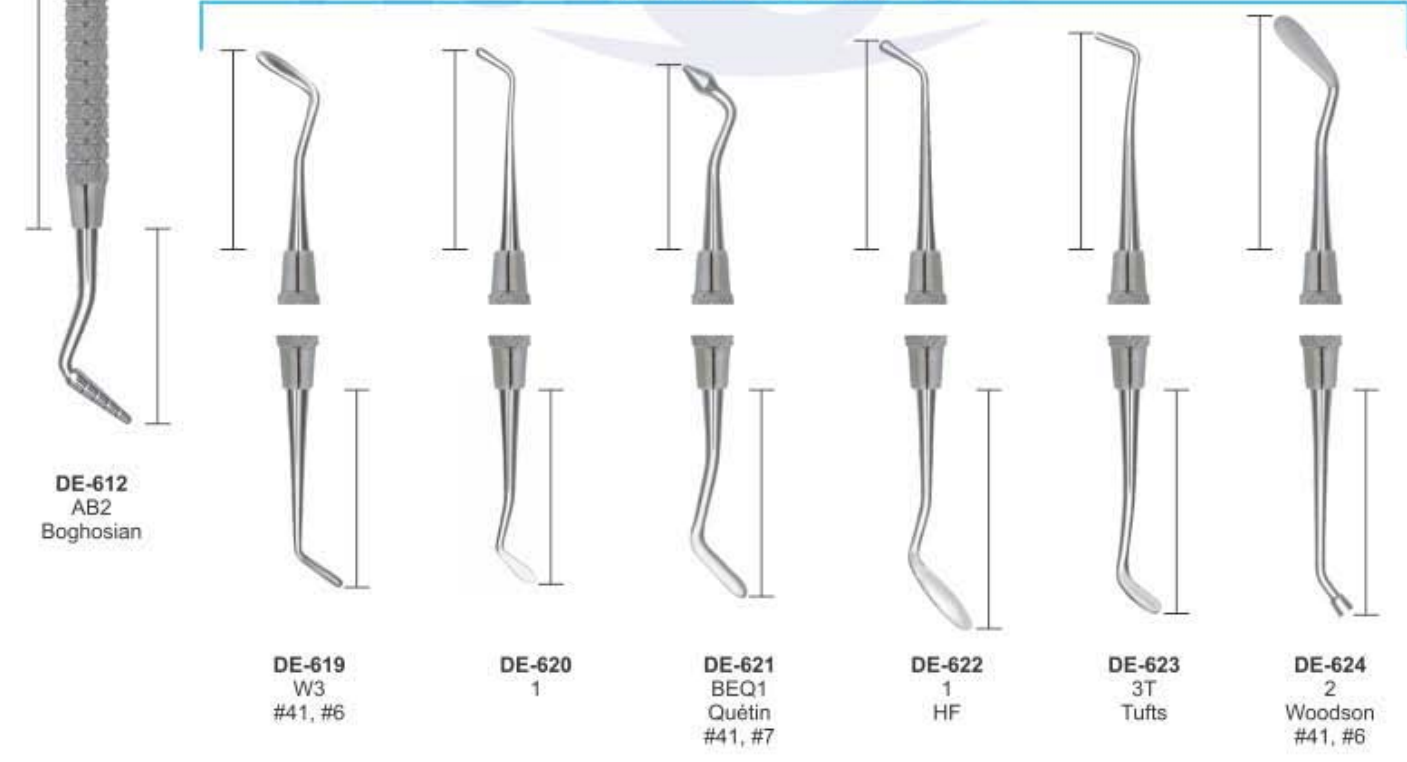

FILLING INSTRUMENTS



- Инструменты для реставрации
- Instruments pour plombage
- Füllungsinstrumente (mit Kontrawinkel)
- Инструменти для реставрації
- Instrumentos para obturaciones
- ملء الصكوك

COMPOSITE/PLASTIC FILLING INSTRUMENTS SOLID HANDLE 6MM, LENGTH 170MM

BLACK

PLUGGERS/CONDENSERS

Hollenback

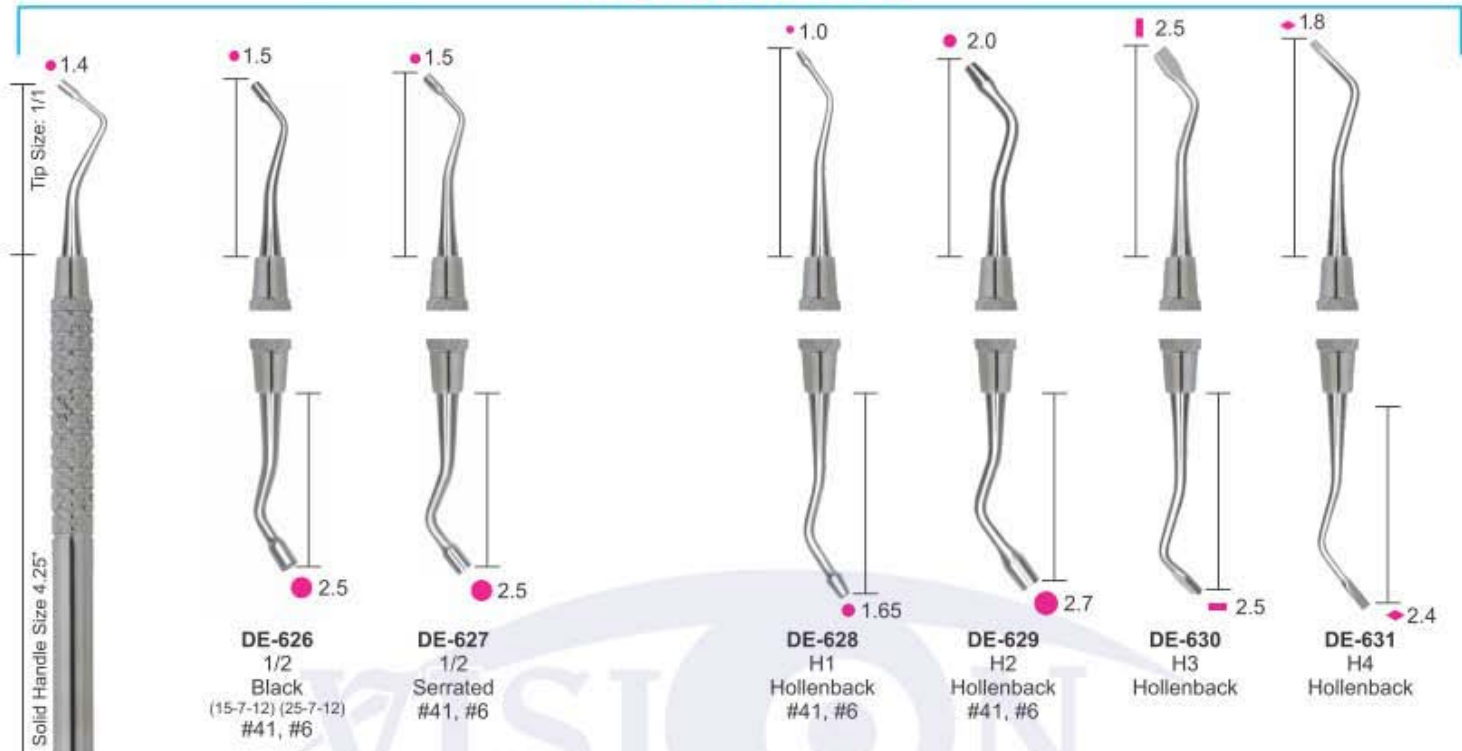

MARQUETTE CONDENSER

MORTONSON

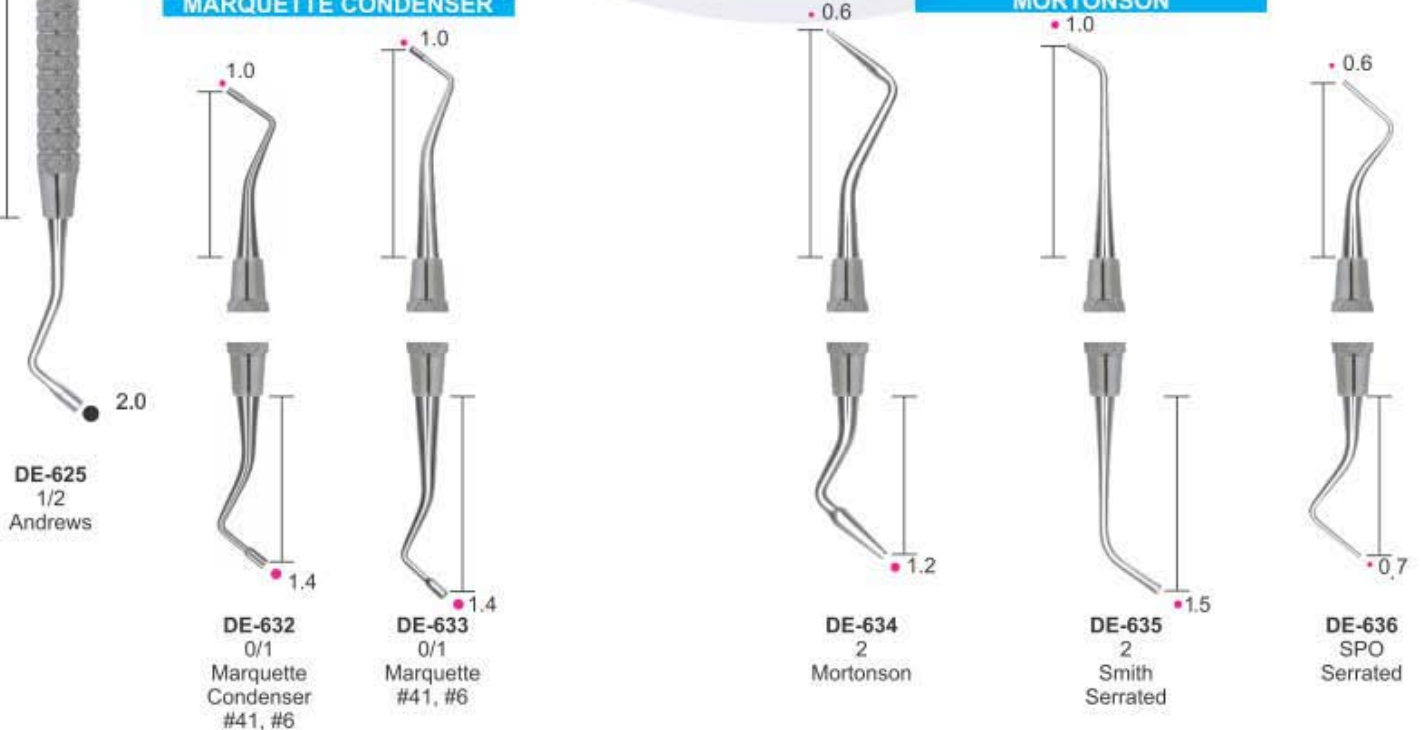

- Инструменты для реставрации
- Instruments pour plombage
- Füllungsinstrumente (mit Kontrawinkel)

- Інструменти для реставрації
- Instrumentos para obturaciones
- ملء الصكوك

PLUGGERS/CONDENSERS

RESTORATIVE INSTRUMENTS SOLID HANDLE 6MM, LENGTH 170MM

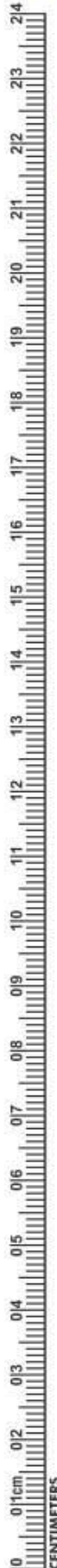

DE-638
2M
Markley

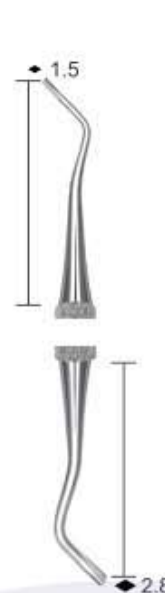

DE-639
4M
Markley

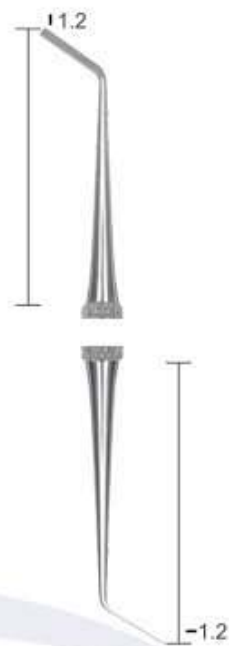

DE-640
5M
Markley

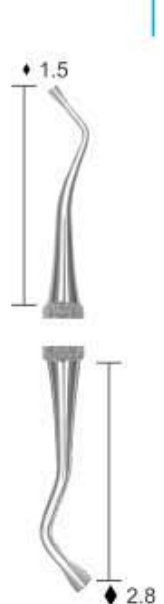

DE-641
6M
Markley

PLUGGERS/CONDENSERS



DE-637
1M
Markley



DE-642
1
Oregon
#41, #6



DE-643
2
Oregon
#41, #6



DE-644
3
Oregon

DE-645
4
Oregon
#41, #6



DE-646
1
Ward



DE-647
2
Ward

FILLING INSTRUMENTS



- Инструменты для реставрации
- Instruments pour plombage
- Füllungsinstrumente (mit Kontrawinkel)
- Инструменти для реставрації
- Instrumentos para obturaciones
- ملء الصكوك

RESTORATIVE INSTRUMENTS SOLID HANDLE 6MM, LENGTH 170MM Back Action Filling Instruments

Tanner Filling Instruments

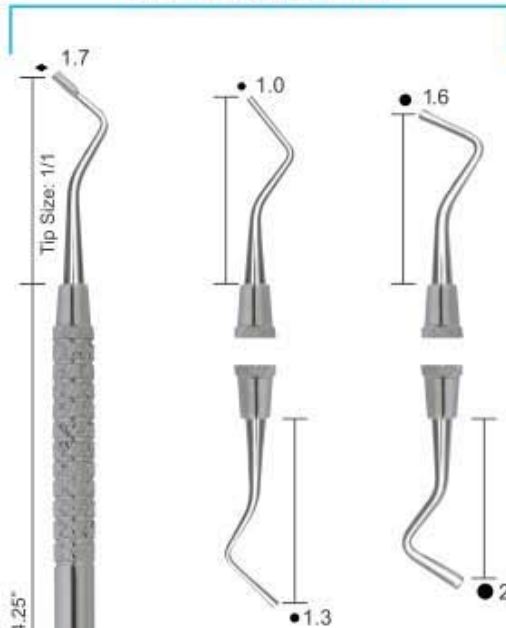

DE-649
2T
Tanner

DE-650
3T
Tanner

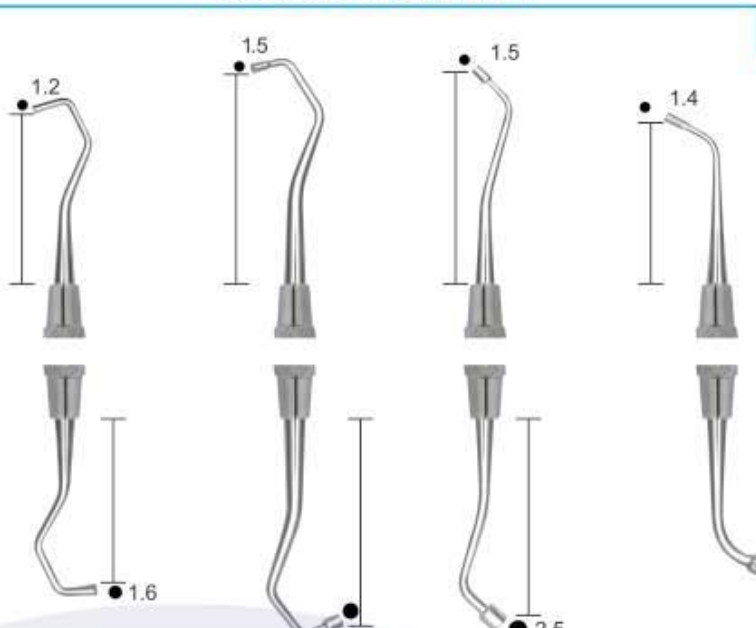

DE-651
9/10
Back Action

DE-652
11/12
Back Action

DE-653
153
English Pattern
Serrated

DE-654
153
English Pattern
Serrated

BURNISHERS

BALL

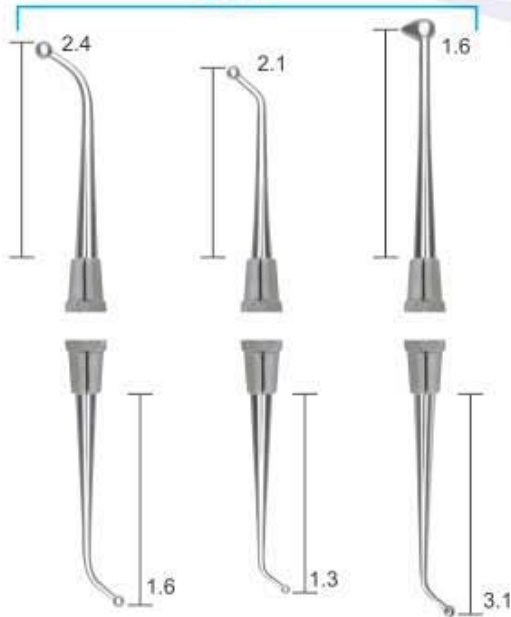

DE-648
1T
Tanner

DE-655
18
#41, #6

DE-656
26/27S
#41, #6

DE-657
27/29
#41, #6, #7, #8

BEAVERTAIL



DE-658
2

DE-659
2
Double-End

ACORN



DE-660
21
#41, #6

DE-661
21B
#41, #6, #8

LADMORE



DE-662
2
Ladmore

- Инструменты для реставрации
- Instruments pour plombage
- Füllungsinstrumente (mit Kontrawinkel)

- Инструменти для реставрації
- Instrumentos para obturaciones
- ملء الصكوك

RESTORATIVE INSTRUMENTS SOLID HANDLE 6MM, LENGTH 170MM

BURNISHERS

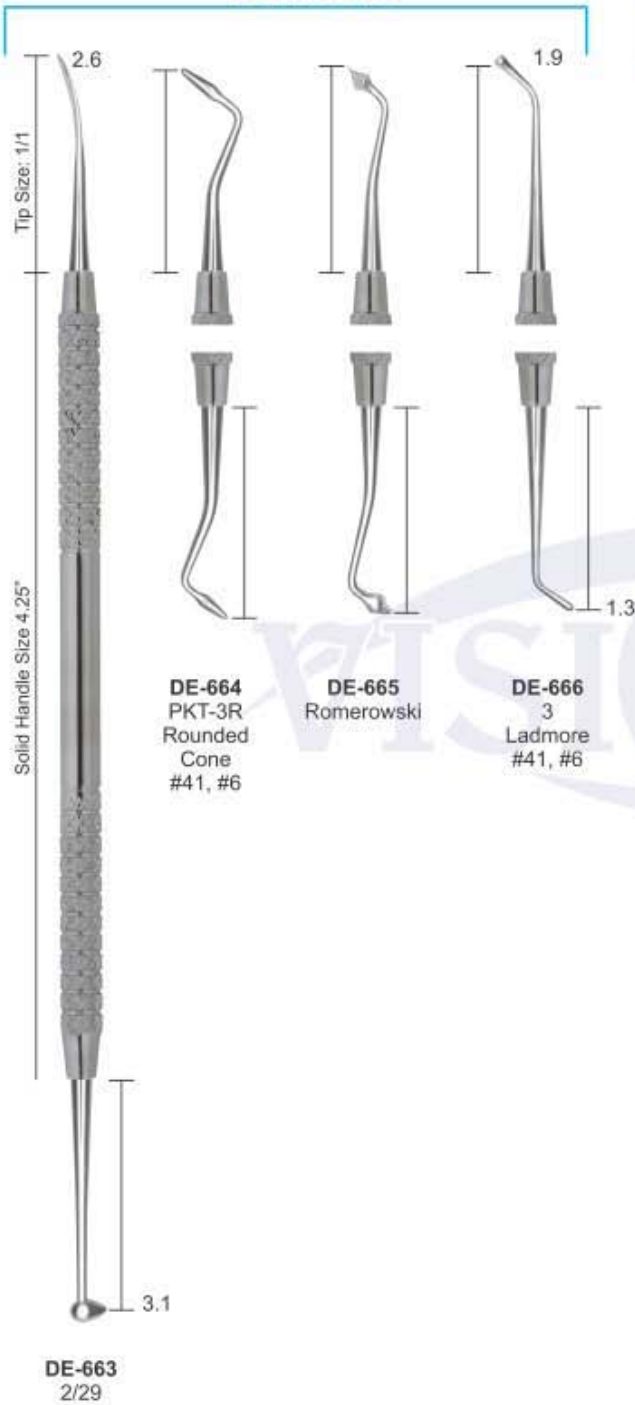

PERIODONTAL FILES

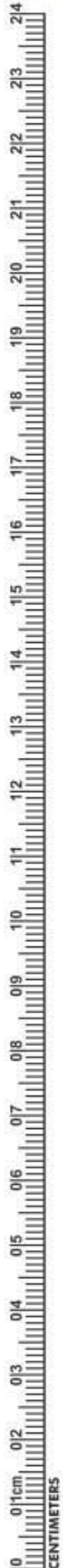

FILLING INSTRUMENTS



- Инструменты для реставрации
- Instruments pour plombage
- Füllungsinstrumente (mit Kontrawinkel)
- Инструменти для реставрації
- Instrumentos para obturaciones
- ملء الصكوك

COMPOSITE/PLASTIC FILLING INSTRUMENTS
SOLID HANDLE 6MM, LENGTH 170MM

BURNISHER FILLING INSTRUMENTS

Tip Size: 1/1

Solid Handle Size 4.25"

DE-672 Interproximal Off-angle	DE-673 2 HF	DE-674 49 Baldwin	DE-675 21 Burnisher #41, #6	DE-676 21B Burnisher #41, #6	DE-677 PKT-3R Rounded- cone #41, #6
---	--------------------------	--------------------------------	---	--	--

UNIVERSAL FILLING INSTRUMENTS

DE-671 AB2 Boghosian	DE-678 W3 #41, #6	DE-679 1	DE-680 BEQ1 Quétin #41, #7	DE-681 1 HF	DE-682 3T Tufts	DE-683 2 Woodson #41, #6
-----------------------------------	--------------------------------	--------------------	--	--------------------------	------------------------------	--

- Инструменты для реставрации
- Instruments pour plombage
- Füllungsinstrumente (mit Kontrawinkel)

- Инструменти для реставрації
- Instrumentos para obturaciones
- ملء الصكوك

FILLING INSTRUMENTS SOLID HANDLE 6MM, LENGTH 170MM

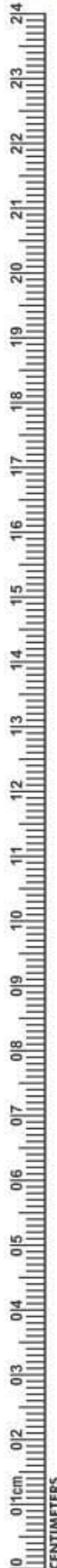

DE-684
Filling
Instrument

DE-694

DE-695

DE-696

DE-697

DE-698
Mortensen

DE-699

DE-700

DE-701

DE-693
Lining Applicator
Double End

AMALGAM CARVERS



- Инструменты для реставрации
- Instruments pour amalgame
- Amalgampistolen
- Инструменти для реставрації
- instrumentos para amalgama
- تطبيع الملقم

AMALGAM INSTRUMENTS SOLID HANDLE 6MM, LENGTH 170MM



- Инструменты для реставрации
- Instruments pour amalgame
- Amalgampistolen

- Инструменти для реставрації
- instrumentos para amalgama
- تقطيع الملعقم

**AMALGAM INSTRUMENTS
SOLID HANDLE 6MM, LENGTH 170MM**

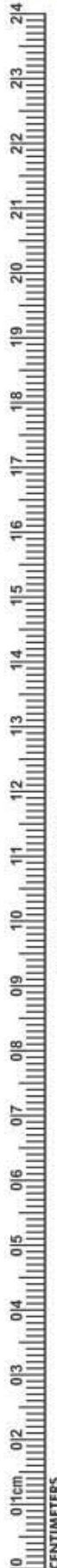

Excavators Instruments Set of 11 Pieces



- Инструменты пародонтологические
- Instruments pour la parodontologie
- Instrumente für die Parodontologie
- Инструменти пародонтологічні
- instrumentos para periodoncia
- الصكوك اللثة

SICKLE SCALERS INSTRUMENTS SOLID HANDLE 6MM, LENGTH 170MM

SICKLE SCALERS



- Инструменты пародонтологические
- Instruments pour la parodontologie
- Instrumente für die Parodontologie

- Інструменти пародонтологічні
- instrumentos para periodoncia
- الصكوك اللثة

PERIODONTAL INSTRUMENTS SOLID HANDLE 6MM, LENGTH 170MM

JACQUETTE SCALERS

CRANE-KAPLAN

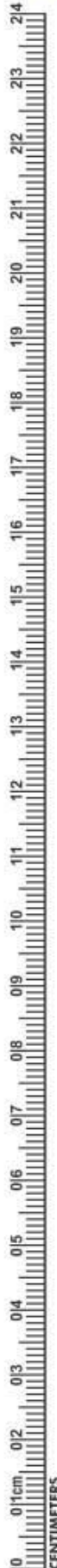

DE-731
30/33
Hygienist
Jacquette
#2, #4, #6,
#7, #8, #9

DE-732
31/32
Jacquette
#2, #4, #6,
#7, #8, #9

DE-733
34/35
Jacquette
#2, #4, #6,
#7, #8, #9

DE-734
H3/H4
Jacquette
#2, #4, #6,

DE-735
14/15
Posterior
Jacquette
#2, #4, #6,

DE-736
CK-6
#2, #4, #6,

- Инструменты пародонтологические
- Instruments pour la parodontologie
- Instrumente für die Parodontologie
- Инструменти пародонтологічні
- instrumentos para periodoncia
- الصكوك اللثة

PERIODONTAL INSTRUMENTS SOLID HANDLE 6MM, LENGTH 170MM SCALER/CURETTE SETS



DE-737
11/12
Scaler
#2, #6,
#7, #8

DE-738
11A/12A
Scaler
#2, #4, #6,

DE-739
11/12S
Modief
McCall
#4, #6

DE-740
13S/14S
Pointed
Curette
#2, #4, #6
#7, #8, #9

DE-741
MTC 13/14
Pointed
Curette
#4, #6

DE-742
17S/18S
Curette
#2, #4, #6
#7, #8, #9

DE-743
19/20
Curette
#2

- Кюрети
- Curetas
- Küretten
- Кюрети
- Curette
- کرتس

SCALER/CURETTE SETS

GOLDMAN-FOX SET

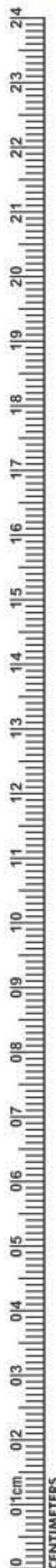

DE-744 103/106 #4, #6	DE-744A 104/105 Hoe/Chisel #4, #6	DE-745 107/108 #2, #4, #6 #7, #8	DE-746 107/108S Modied #2, #4	DE-747 1/2 (shown) #2, #4, #6 #7, #8, #9	DE-749 3/4† (shown) #2, #4, #6 #7, #8, #9	DE-751 5/6† (shown) #2, #4, #6 #7, #8, #9	DE-754 7/8† (shown) #2, #4, #6 #7, #8, #9		
				DE-748 1/2 Rigid #2, #4, #6 #7, #8, #9	DE-750 3/4 Rigid #2, #4, #6 #7, #8, #9	DE-752 5/6 Rigid #2, #4, #6 #7, #8, #9	DE-753 5/6 Extra Rigid #4, #6 #7, #8	DE-755 7/8 Rigid #2, #4, #6 #7, #8, #9	DE-756 7/8 Extra Rigid #2, #4, #6 #7, #8, #9

**SCALER/CURETTE SETS INSTRUMENTS
SOLID HANDLE 6MM, LENGTH 170MM**

CURETTES



- Кюрети
- Curetas
- Küretten
- Кюрети
- Curette
- كرتس

GRACEY CURETTE INSTRUMENTS SOLID HANDLE 6MM, LENGTH 170MM GRACEY CURETTES



DE-757
9/10†
(shown)
#2, #4, #6
#7, #8, #9

DE-759
11/12†
(shown)
#2, #4, #6
#7, #8, #9

DE-792
13/14†
(shown)
#2, #4, #6
#7, #8, #9

DE-765
15/16†
(shown)
#2, #4, #6
#7, #8, #9

DE-767
17/18
#2, #4, #6
#7, #8, #9

DE-758
9/10
Rigid
#2, #4, #6
#7, #8

DE-760 **DE-761**
11/12 11/12
Rigid Extra Rigid
#2, #4, #6 #4, #6 #7,
#7, #8, #9 #8

DE-793 **DE-764**
13/14 13/14
Rigid Extra Rigid
#2, #4, #6 #4, #6 #7,
#7, #8, #9 #8

DE-766
15/16
Rigid
#2, #4, #6
#7, #8, #9

DE-768
17/18
Rigid
#2, #4, #6
#7, #8, #9



- Кюрети
 - Curetas
 - Küretten
- Кюрети
 - Curette
 - کرتس

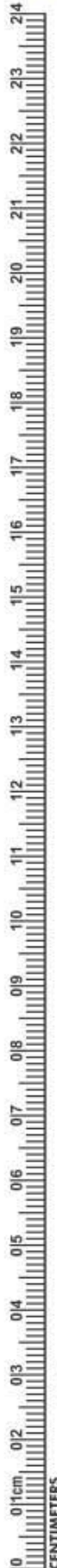

**CURETTE INSTRUMENTS
HOLLOW HANDLE 8.5MM, LENGTH 170MM**

**CURETTE INSTRUMENTS
SOLID HANDLE 6MM, LENGTH 170MM**

**CURETTE INSTRUMENTS
SOLID HANDLE 6MM, LENGTH 170MM**



DE-769
Hemingway
2mm, 2mm

DE-770
Hemingway
3mm, 3mm

DE-771
Hemingway
4mm, 4mm

DE-772
Hemingway
2mm, 2mm

DE-773
Hemingway
3mm, 3mm

DE-774
Hemingway
4mm, 4mm

DE-775
Hemingway
2mm, 2mm

DE-776
Hemingway
3mm, 3mm

DE-777
Hemingway
4mm, 4mm

EXCAVATORS



- Экскаваторы
- Excavateurs
- Excavatoren
- Excavatori
- Excavadores
- حفارات

EXCAVATORS INSTRUMENTS SOLID HANDLE 6MM, LENGTH 170MM SPOONS



- Экскаваторы
- Excavateurs
- Excavatoren
- Екскаватори
- Excavadores
- حفارات

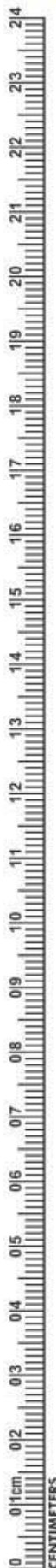

**EXCAVATORS INSTRUMENTS
SOLID HANDLE 6MM, LENGTH 170MM**

OVAL SPOONS/DARBY-PERRY

EXCAVATORS

Model	Tip Size	Category
DE-787 17W	1.2	Oval Spoons/Darby-Perry
DE-788 18W	1.5	Oval Spoons/Darby-Perry
DE-789 19W	1.8	Oval Spoons/Darby-Perry
DE-790 220/221 Darby-Perry #41, #6	1.5	Oval Spoons/Darby-Perry
DE-791 2 Glick	1.5	Excavators
DE-792 31L #41, #6	1.0	Excavators
DE-793 31W Oval Spoon	1.3	Excavators
DE-794 32L #41, #6	1.5	Excavators
DE-795 33L #41, #6	2.0	Excavators

- Экскаваторы
- Excavateurs
- Excavatoren
- Excavatori
- Excavadores
- حفارات

**EXCAVATORS INSTRUMENTS
SOLID HANDLE 6MM, LENGTH 170MM**

BLADES



- Экскаваторы
- Excavateurs
- Excavatoren
- Бкскаватори
- Excavadores
- حفارات

EXCAVATORS INSTRUMENTS SOLID HANDLE 6MM, LENGTH 170MM

ENGLISH PATTERNS

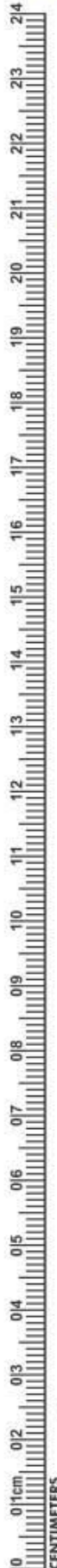

DE-802 Goldstein Interproximal Excavator	DE-803 243	DE-804 244	DE-805 245	DE-806 246	DE-807 125/126 #41, #6	DE-808 127/128 #41, #6	DE-809 129/130 #41, #6	DE-810 131/132 #41, #6	DE-811 153/154
--	----------------------	----------------------	----------------------	----------------------	-------------------------------------	-------------------------------------	-------------------------------------	-------------------------------------	--------------------------

FILLING INSTRUMENTS



- Инструменты для реставрации
- Instruments pour plombage
- Füllungsinstrumente (mit Kontrawinkel)
- Инструменти для реставрації
- Instrumentos para obturaciones
- ملء الصكوك

HATCHETS

RESTORATIVE INSTRUMENTS SOLID HANDLE 6MM, LENGTH 170MM

Tip Size: 1/1

Solid Handle Size 4.25"

DE-813
13/14
(20-9-14)

DE-814
15/16
(15-8-14)

DE-815
17/18
(10-6-14)
#41, #6

DE-816
51/52
(15-8-12)

DE-817
53/54
(10-6-12)
#41, #6

DE-812
8/9H
(10-7-14)
#41, #6

DE-818
8A
#41, #6

DE-819
11
#41, #6

DE-820
179

DE-821
G

DE-822
1/2
Trico

DE-823
DPT6
Darby Perry
Trimmer

DE-824
W1

DE-825
1
Woodson
#41, #6

ANTERIOR

INCHES

- Инструменты для реставрации
- Instruments pour plombage
- Füllungsinstrumente (mit Kontrawinkel)

- Инструменти для реставрації
- Instrumentos para obturaciones
- ملء الصكوك

CARVERS

RESTORATIVE INSTRUMENTS SOLID HANDLE 6MM, LENGTH 170MM

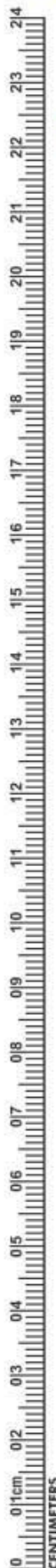

Tip Size: 1/1

Solid Handle Size 4.25"

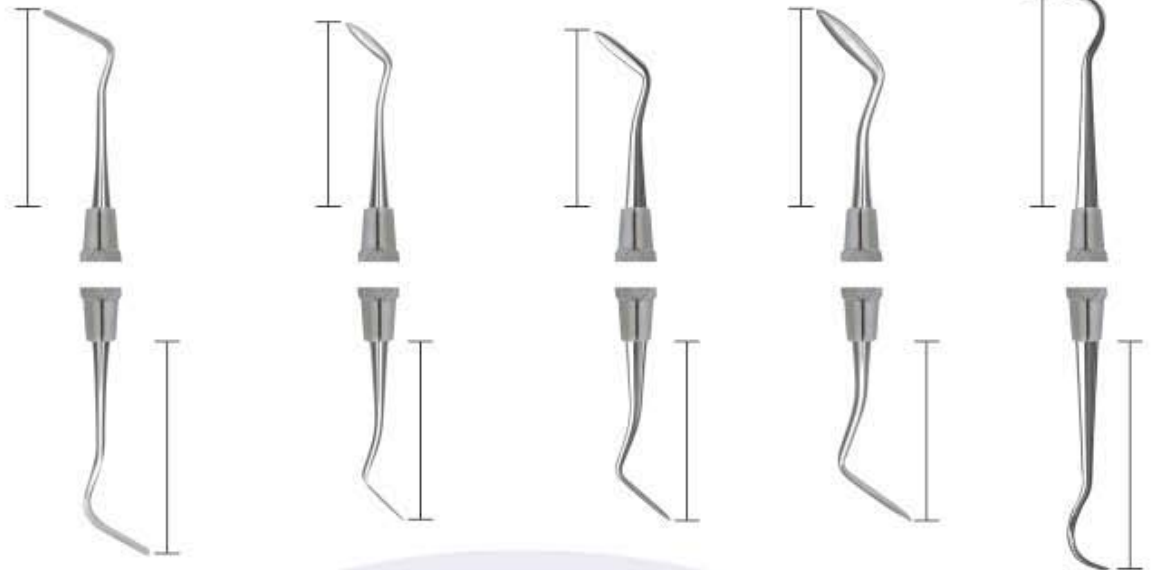

DE-827
Inter-proximal
Off-Angle

DE-828
1/2-3
Hollenback
#41, #6,
#7, #8

DE-829
3S
Hollenback
#41, #6, #7

DE-830
3
Hollenback

DE-831
8
Wiland
Minn.IPC1
#41, #6, #7

TANNER

WALL

WARD

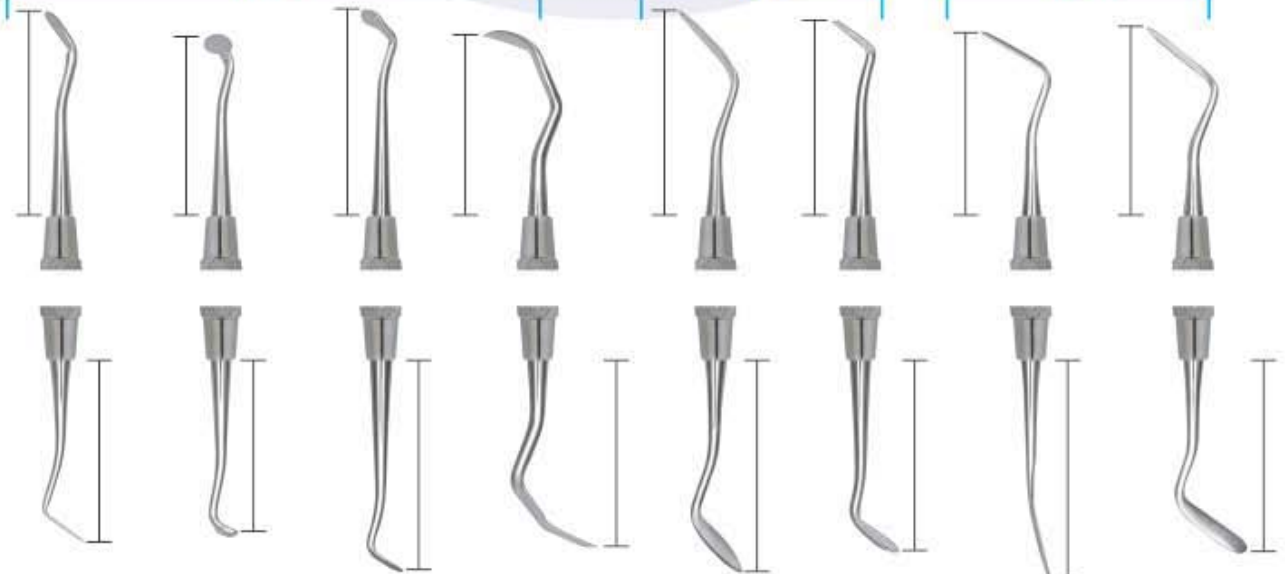

DE-826
Inter-proximal
#41, #6, #7

DE-832
3
Tanner

DE-833
4
Tanner

DE-834
5
Tanner

DE-835
6
Tanner

DE-836
1
Wall

DE-837
3
Wall

DE-838
1
Ward

DE-839
2
Ward

AMALGAM CARVERS



- Инструменты для реставрации
- Instruments pour amalgame
- Amalgampistolen
- Инструменти для реставрації
- instrumentos para amalgama
- نظطیع الملقم

RESTORATIVE INSTRUMENTS

ANDREW SOLID HANDLE 6MM, LENGTH 170MM CLAPPISON/FRAHAM

HOLLENBACK



DE-841
2
Andrew

DE-842
3
Andrew

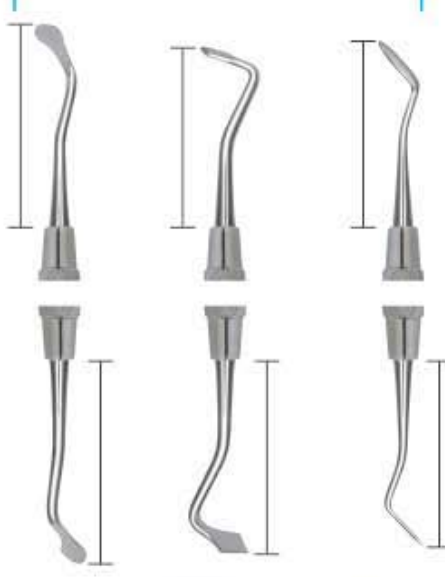

DE-843
4
Clappison

DE-844
2/3
Frahm
#41, #6

DE-845
104



DE-846
1 Hollenback
2 Modified
Cleoid Small

DE-847
1 Hollenback
2 Modified
Cleoid Large



HOLLENBACK

THARP



DE-848
1
Hollenback

DE-849
2
Hollenback



DE-850
L7
Levy

DE-851
SHO-A
Shoshan

DE-852
18
Sprengel

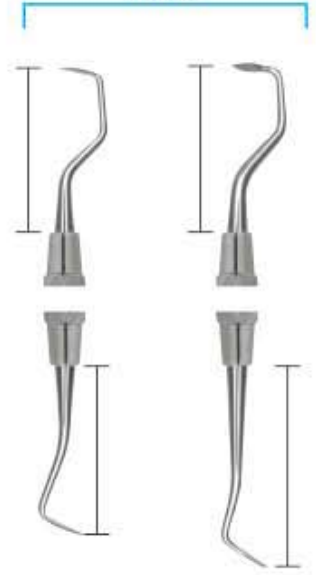

DE-853
1
Tharp

DE-854
2
Tharp

DE-840
1
Andrew



- Инструменты для реставрации
- Instruments pour amalgame
- Amalgampistolen

- Инструменти для реставрації
- instrumentos para amalgama
- تقطيع الملعق

RESTORATIVE INSTRUMENTS SOLID HANDLE 6MM, LENGTH 170MM

CARVERS

AMALGAM FILES

HOES

Forming Line Angles on Anterior Preparations.

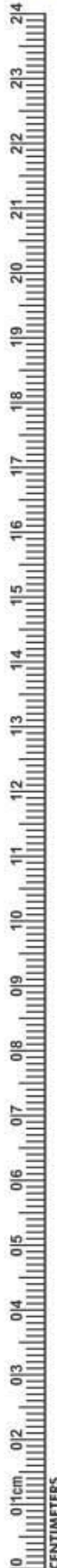

DE-856
Discoid-Cleoid Carver
Tip Size: 1/1
Solid Handle Size 4108mm

DE-855
Anatomical Carver
Solid Handle Size 4108mm

DE-857
31/32 Rhein
Solid Handle Size 122mm

DE-858
1/4 Wedelstaedt
Solid Handle Size 122mm

DE-859
2/5 Wedelstaedt
Solid Handle Size 122mm

DE-863
20
(14-6-8)
Solid Handle Size 122mm

DE-864
21
(10-4-8)

DE-865
22
(10-4-14)

DE-866
23
(6.5-2.5-9)

DE-860
1/2

DE-861
4/5
#41, #6, #7

DE-862
3/6
#41, #6, #7

DE-867
89/92
#41, #6, #7

DE-868
90B

DE-869
W-A-C-D

DISCOID-CLEOIDS (1.5, 2.0, 3.0)

DISCOID-CLEOIDS

FILLING INSTRUMENTS



- Инструменты для реставрации
- Instruments pour plombage
- Füllungsinstrumente (mit Kontrawinkel)
- Инструменти для реставрації
- Instrumentos para obturaciones
- ملء الصكوك

RESTORATIVE INSTRUMENTS
SOLID HANDLE 6MM, LENGTH 170MM

MARGIN TRIMMERS



DE-870
26
(13-95-8-14)
Distal



DE-871
27
(13-80-8-14)
Mesial



DE-872
28
(10-95-7-14)
Distal
#41, #6



DE-873
29
(10-80-7-14)
Mesial
#41, #6



DE-874
77/78
(15-95-8-12)
Distal



DE-875
79/80
(15-80-8-12)
Mesial

ANGLE FORMERS



DE-876
30/31
(12-80-5-8)



DE-877
32/33
(9-80-4-8)



DE-878
34/35
(7-80-2.5-9)



- Инструменты для реставрации
- Instruments a modeler
- Modellierinstrumente

- Инструменти для реставрації
- Instrumentos para modelar
- ابوات تقطیع

P.K. THOMS WAXING INSTRUMENTS SOLID HANDLE 6MM, LENGTH 170MM

P.K. THOMAS WAXING INSTRUMENTS

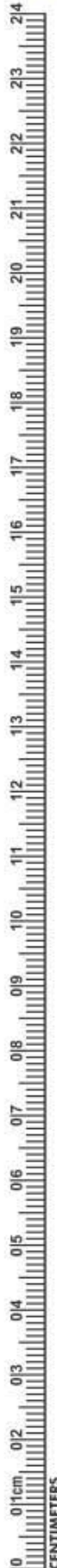

DE-879
PKT-1

DE-880
PKT-2

DE-881
PKT-3
#41, #6

DE-882
PKT-3R
Rounded
Cone

DE-883
PKT-4

DE-884
PKT-5

FILLING INSTRUMENTS



- Инструменты для реставрации
- Instruments pour plombage
- Füllungsinstrumente (mit Kontrawinkel)
- Инструменти для реставрації
- Instrumentos para obturaciones
- ملء الصكوك

CHISELS

HOES



- Шпатели для цемента
- Spatules à ciment
- Zementspatel

- Шпатели для цементу
- Espátulas para cemento
- ملاعق الأسمنت

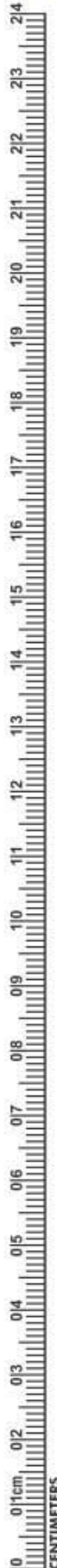

DE-893 00 DE-894 0 DE-895 1 DE-896 2 DE-897 3 DE-898 4 DE-899 3 Weston DE-900 1 medium cement DE-901 1



DE-902 Le Cron DE-903 Le Cron DE-904 Le Cron DE-905 MSY DE-906 MSY DE-907 Le Cron DE-908 Hylin DE-909 Hylin DE-910 Hylin DE-911 Zahle DE-912 Zahle DE-913 Zahle DE-914 Gritman

WAX KNIVES



- Ножи для воска
- Couteaux a cire
- Wachsmesser
- Ножи для воску
- Cuchillos para cera
- السكاكين الشمع

ALGINATE, PLASTER SPATULAS, WAX KNIVES PLASTER FOR KNIVES & PLASTER SHEAR



DE-915
Wooden Handle
Fig. 5
21.5 cm



DE-916
Wooden Handle
Fig. 7
19.5 cm curved



DE-917
Wooden Handle
Fig. 8
20 cm curved



DE-918
Wooden Handle
Fig. 9
22.5 cm curved



DE-919
Hook Knives



DE-920
Fig. 1
Lessmann
12.5 cm



DE-921
Fig. 2
Lessmann
17 cm



DE-922
Fig. 1
with small spoon
12.5 cm



DE-923
Fig. 2
with large spoon
17 cm



DE-924
Bacolite Handle
Wax Knives,
Small



DE-925
Bacolite Handle
Wax Knives,
Large



DE-926
Wooden Handle
Wax Knives,
Small



DE-927
Wooden Handle
Wax Knives,
Large



DE-928
Plaster Knife



DE-929
Fig. 1
17 cm



DE-930
Fig. 3
16 cm



DE-931
Fig. 4
16 cm



DE-932
Special Inox
19.5 cm



- Артикуляторы
- Artocilar
- Artikulations

- Артикулятори
- Articular
- ارتیکو لائو رس



DE-933

Technical Datas:

Intercondylar distance	120 mm.
condylar inclination	fixed at 30°
Bennet angle	fixed at 7°
Incisal table inclination	10°
Distance between mounting plates	85 mm.
Weight	400 gr.
Opening (item 5000)	125°
Opening (item 5010)	180°



DE-934

Technical Datas:

Intercondylar distance	110 mm.
condylar inclination	fixed at 30°
Bennet angle	fixed at 7°
Incisal table inclination	flat
Distance between mounting plates	85 mm.
Weight	450 gr.
Opening	180°



DE-935

Stainless Steel Finishing
DE-936
Royal Blue

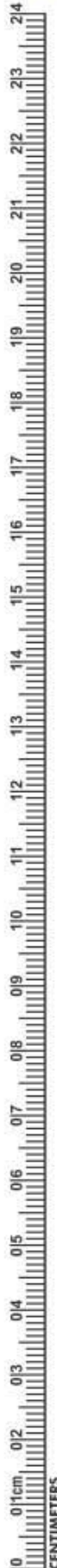

DE-937



DE-938



DE-939



DE-940



DE-941



DE-942



DE-943



DE-944



DE-945



DE-946
Nakawalni
Dental Laboratory
Instrument

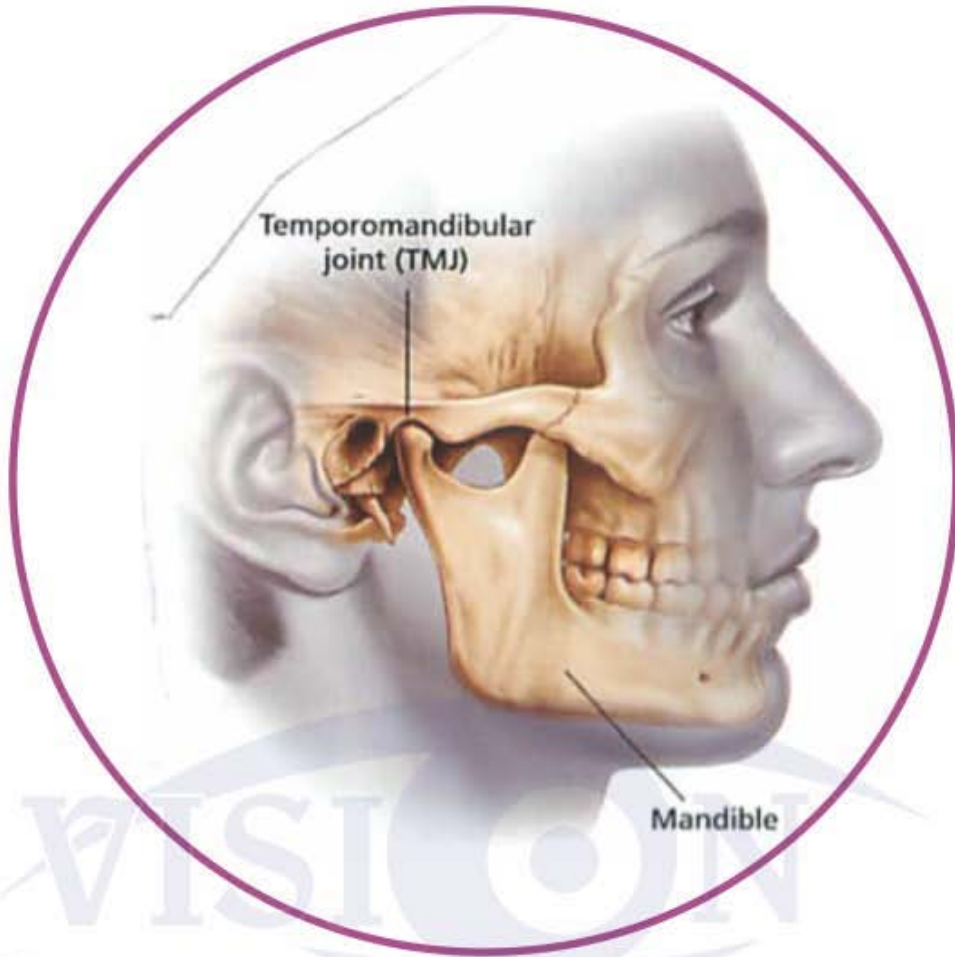

- Роторасширители
- Ecarteurs - Ouvre-bouches
- Vestibulumabhalter / Mundspanner
- Роторозширювачі
- Separadores - Abre-bocas
- الكاشطات - الكمامات الفم

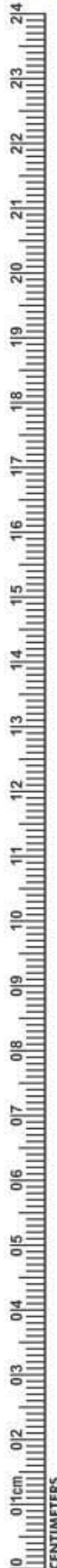

DE-947
Mouth Gag Molt
11 cm for (Children)



DE-948
Mouth Gag Molt
14 cm for (Adults)



Cheek Retractor
DE-949 140 mm
DE-950 180 mm



Cheek Retractor
DE-951 140 mm



DE-952
Wangen Holder,
vestibule
15 cm, with or without
lip protection,



DE-953
Wangen Holder,
vestibule 15 cm, with
or without lip protection,



DE-954
Wangen Holder
Wangen holder with dual
function, 17 cm,



DE-955
140 mm

DE-956
150 mm

Cheek Retractor

RETRACTORS - MOUTH GAGS



- Роторасширители
- Ecarteurs - Ouvre-bouches
- Vestibulumabhalter / Mundspanner
- Роторозширювачі
- Separadores - Abre-bocas
- الكاشطات - الكمامات الفم



DE-957
Fig. 1
weitlaner
10.5cm
13.5cm



DE-958
Fig. 2
weitlaner
10.5cm
13.5cm



DE-959
Stainless Steel
Double
Ended Cheek
Retractors



DE-960
Stainless Steel
Single
Ended Cheek
Retractors



Weitlander
DE-961 11cm
DE-962 13cm
DE-963 15cm



DE-967
Denhard
12 cm



DE-968
Roser-König
16 cm



DE-969
Roser-König
19 cm



Jennings
DE-964 11cm
DE-965 13cm
DE-966 15cm



Wound, Bendable
Retractor, individually or as saving kit!

- Ранорасширители
- Ecarteurs
- Wundhaken

- Ранорозширювачі
- Separadores
- الكاشطات

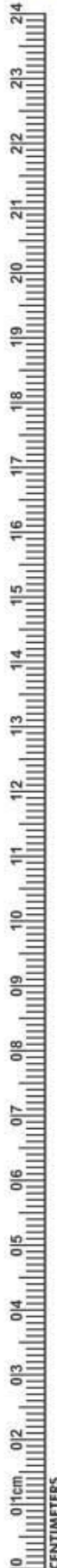

DE-970
Cheek Retractor
Long



DE-971
Cheek Retractor
Long



DE-972
Cheek Retractor
Long



Retractor with Ergo Grip DE-973 24 cm, ergonomic handle,



DE-974
Cheek Retractors,
Retractor Ivory
Width adjustable & fixable, 20 cm,



Cheek Retractors, tongue depressors DE-975 19 cm



Cheek Retractors, Minnesota DE-976 16 cm



Cheek Retractors, DE-977 20 cm easy to bend by hand,



Cheek Retractors, retractor and tongue pushers BISHOP DE-978 16 cm,



Retractors Cheek retractor combination DE-979 25 cm,

RETRACTORS



- Ранорасширители
- Ecarteurs
- Wundhaken
- Ранорозширювачі
- Separadores
- الكاشحات



DE-982
Retractors, Unique
Length 175 mm,
angled 45 °



DE-983
Retractors, Unique
Length 175 mm,
angled 90°



DE-984
Retractors
16cm



DE-985
Retractors
19cm



DE-986
Retractors, Mini-Langenbeck
16 cm, hooks 22 mm,



DE-987
Retractors, Cheek
retractors combination
21 cm, 2



DE-988
Mini Retractor
about 8 cm,



DE-989
Retractors
17 cm, hooks 22 mm



- Ранорасширители
 - Ecarteurs
 - Wundhaken
- Ранорозширювачі
 - Separadores
 - الكاشطات



DE-990
Retractors, surgical-flat
surgically-flat, 21 cm, hook
30x16 mm,



DE-991
Retractors, surgical-flat
surgically-flat, 21 cm, hook
42x11 mm



DE-992
Retractors, surgical-flat
surgically-flat, 21 cm, hook
63x12 mm,



Retractors, surgical-flat
surgically-flat, 21 cm, hook
DE-993 30x16 mm,
DE-994 42x11 mm,
DE-995 63x12 mm,



Retractors, Langenbeck
21 cm, hook
DE-996 30x11 mm
DE-997 30x16 mm,



DE-998
Retractors
21 cm,



DE-999
Farabeuf
(120 X 12mm
Set of 2 pices)



DE-1000
Retractor Seldin



DE-1001
FELDMAN
RETRACTOR
5-1/2", 14cm

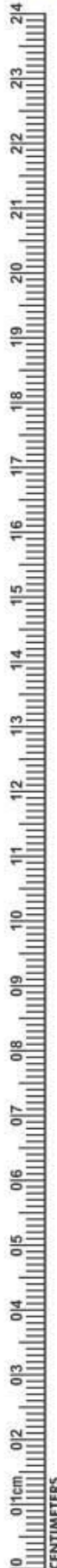

GUM SCISSORS



- Ножницы десневые
- Ciseaux a gencives
- Zahnfleischscheren
- Ножиці для ясен
- Tijeras para encias
- مقص صمغ



DE-1002
Iris
115mm
Straight



DE-1003
Iris
115mm
Curved



DE-1004
Goldman-Fox
130mm
Saw edge, straight



DE-1005
Goldman-Fox
130mm
Saw edge, Curved



DE-1006
La Grange
115mm
Saw edge, double Curved



Mayo
DE-1007 140mm
DE-1008 170mm
DE-1009 230mm
Straight



Mayo
DE-1010 140mm
DE-1011 170mm
DE-1012 230mm
Curved



Metzenbaum
DE-1013 145mm
DE-1014 180mm
DE-1015 200mm
Straight



Metzenbaum
DE-1016 145mm
DE-1017 180mm
DE-1018 200mm
Curved



DE-1019
Kelly
160mm
Straight



DE-1020
Kelly
160mm
Curved



DE-1021
Iris
115mm
Straight



DE-1022
Iris
115mm
Curved



DE-1023
La Grange
115mm
Double Curved



DE-1024
Goldman-Fox
130mm, Straight



DE-1025
Goldman-Fox
130mm, Curved



DE-1026
Kelly
160mm, Curved



DE-1027
Iris
115mm, Straight



DE-1028
Iris
115mm, Curved



DE-1029
Micro Iris
90mm, Curved



- Ножницы десневые
- Ciseaux a gencivas
- Zahnfleischscheren

- Ножиці для ясен
- Tijeras para encias
- مقص صغ

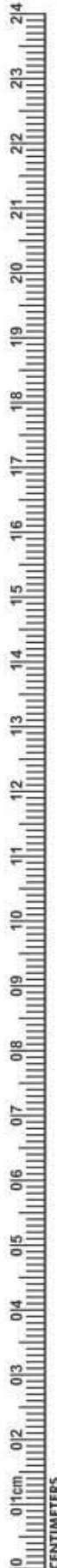

DE-1030
Iris
115mm
Angled



DE-1031
Iris
115mm
Curved



DE-1032
Goldman-Fox
130mm
Saw edge,
straight



DE-1033
Goldman-Fox
130mm
Saw edge,
curved



DE-1034
Goldman-Fox
130mm
Saw edge,
double curved



DE-1035
La Grange
115mm
Saw edge,
double curved



DE-1036
Neumann
120mm
Saw edge,
double curved



DE-1037
Kilner (Ragnell)
120mm
Straight



DE-1038
Kilner (Ragnell)
120mm
Curved



DE-1039
Joseph
140mm
Straight



DE-1040
Joseph
140mm
Curved



DE-1041
Kelly
160mm
Straight



DE-1042
Kelly
160mm
Curved



DE-1043
Locklin
160mm
Saw edge,
angular



DE-1044
Locklin
120mm
160mm
Saw edge,
angular



DE-1045
Dean
170mm
Saw edge,
angular



DE-1046
Spencer
90mm



DE-1047
Spencer
130mm



DE-1048
Spencer
115mm



DE-1049
Noyes
110mm, Straight



DE-1050
Noyes
110mm
Curved



DE-1051
Noyes
110mm
Angular



DE-1052
Castroviejo
150mm
Curved

NEEDLE HOLDERS



- Иглодержатели
 - Porte-aiguilles
 - Nadelhalter
- Голкотримачи
 - Porta-agujas
 - اصحاب ابرة



DE-1053
130mm
Straight



DE-1054 Mayo
130mm 130mm
DE-1055 Mayo
160mm 160mm
DE-1056 Mayo
180mm 180mm
Straight Curved



DE-1057 Mayo
140mm 140mm
DE-1058 Mayo
200mm 200mm
Straight Curved



DE-1059 Metzenbaum
145mm 145mm
DE-1060 Metzenbaum
200mm 200mm
Straight Curved



DE-1061
Beebee
110mm
Saw edge,
straight



DE-1062
Beebee
110mm
Saw edge,
curved



DE-1063
Beebee
110mm
Saw edge, straight



DE-1064
Beebee
110mm
Saw edge, curved

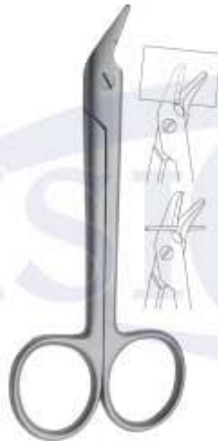

DE-1065
Universal
120mm
Saw edge



DE-1066
Universal
120mm



Crile
DE-1067 130mm
DE-1068 150mm
DE-1069 180mm



DE-1070
Halsey
130mm



DE-1071
Baumgartner
130mm



DE-1072
Derf
120mm



DE-1073
Delicate
150mm



Mayo-Hegar
DE-1074 130mm
DE-1075 160mm
DE-1076 180mm
DE-1077 200mm



DE-1078
Crile-Wood
150mm
straight



DE-1079
Crile-Wood
150mm
curved



- Иглодержатели
- Porte-aiguilles
- Nadelhalter

- Голкотримачи
- Porta-agujas
- اصحاب ابرة

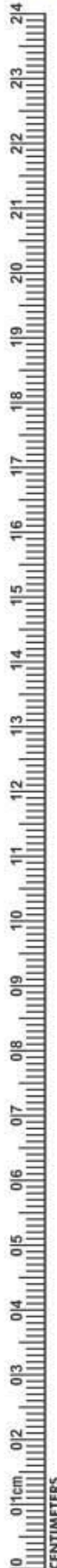

Castroviejo
DE-1080 130mm
DE-1081 150mm
DE-1082 180mm



DE-1083
 Halsey
 130mm



DE-1084
 Baumgartner
 130mm



DE-1085
 Derf
 120mm



DE-1086
 Delicate
 150mm



DE-1087
 Adson
 170mm



Mayo-Hegar
DE-1088 130mm
DE-1089 160mm
DE-1090 180mm
DE-1091 200mm



DE-1092
 Crile-Wood
 150mm



Castroviejo
DE-1093 str 140mm cvd
DE-1094 str 180mm cvd



Olsen-Hegar Needle
 Holder With Scissors
DE-1095 140mm



Gillies Needle
 Holder With Scissors
DE-1096 160mm



Mathieu
DE-1097 140mm
DE-1098 170mm



Castroviejo
DE-1099 str 140mm cvd
DE-1100 str 180mm cvd



Olsen-Hegar Needle
 Holder With Scissors
DE-1101 140mm



Gillies Needle
 Holder With Scissors
DE-1102 160mm



Hartmann (Baby
 Mosquito)
DE-1103 90mm straight



Halstead Mosquito
DE-1105 125mm
 Straight

DE-1106
 Curved

HAEMOSTATIC FORCEPS & TOWEL CLAMPS



- Зажимы артериальные, зажимы для салфеток
- Pinces hemostatiques, Pincers a compresses
- Arterienklemmen, Tuychklemmen
- Затискачі артеріальні, затискачі для серветок
- Pinzas hemostaticas, Pincers para compressas
- المنطق هيموستاتيک المشابك منشفة

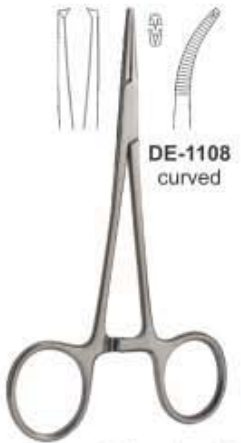

Halstead Mosquito 1x2
DE-1107 125mm
straight



Kelly
DE-1109 140mm
straight



Rochester-Pean
DE-1111 140mm
DE-1112 160mm
DE-1113 180mm
DE-1114 200mm
straight



Rochester-Kocher 1x2
DE-1119 140mm
DE-1120 160mm
DE-1121 180mm
DE-1122 200mm
straight



DE-1127
Kelly-Rankin
160mm
straight



Lorna
DE-1129 100mm
DE-1130 130mm



DE-1131
Allis-Baby 3:4
150mm



DE-1132
Allis 4:5
200mm



DE-1133
Allis 6:7
200mm



Backhaus
DE-1134 140mm
Not-perforating and
not-damaging



DE-1135
Backhaus
130mm



DE-1136
Backhaus
85mm



DE-1137
Jones
90mm



Gross Maier
Dressing Forceps
DE-1138 200mm straight

DE-1139
curved



Foerster
Dressing Forceps
DE-1140 200mm



Young
Tongue Forceps
DE-1141 170mm

Spare rubber



Collins
Tongue Forceps
DE-1142 170mm



- Инструменты для системы коффердам
- Pincas porte-crampons a digue
- Kofferdam Klammerzangen
- Инструменти для системи коффердам
- Pinzas de engrapar para dique de caucho
- السد المطاط الملقط المشابك



DE-1143

On request the Content of the rubber dam kit can be changed with other instruments.

Content:

- | | |
|---|--|
| <ul style="list-style-type: none"> 01 Anisworth 02 Brewer 03 Clamps Stand 04 Denture Plate 05 Rubber Dam Frame 06 Rubber Dam Box Lower Case 07 Rubber Dam Box Upper Case | <ul style="list-style-type: none"> 08 Rubber Dam Clamp Fig. 212 09 Rubber Dam Clamp Fig. 211 10 Rubber Dam Clamp Fig. 8 11 Rubber Dam Clamp Fig. 8A 12 Rubber Dam Clamp Fig. 14 13 Rubber Dam Clamp Fig. 14A 14 Rubber Dam Clamp Fig. 0 15 Rubber Dam Clamp Fig. 00 16 Rubber Dam Clamp Fig. 2 17 Rubber Dam Clamp Fig. 2A 18 Rubber Dam Clamp Fig. 7 |
|---|--|



DE-1144
Anisworth



DE-1145
Brewer



DE-1146
Ivory light weight



DE-1147
Palmer



DE-1148
Seaparing
Elastic
Plier

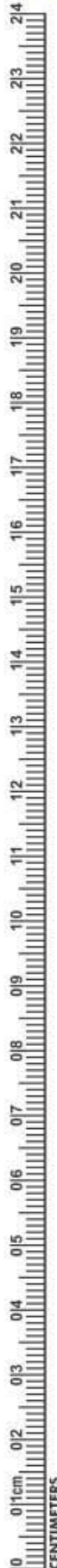

RUBBER DAM CLAMPS



- Кляммера для коффердама
- Crampons pour digue
- Kofferdam Klammern
- Кляммера для коффердама
- Grapas para dique de caucho
- المشابك السد المطاط



DE-1149
Fig. 15



DE-1150
Fig. 18



DE-1151
Fig. 24



DE-1152
Fig. 25



DE-1153
Fig. 26



DE-1154
Fig. 28



DE-1155
Fig. 30



DE-1156
Fig. 31



DE-1157
Fig. 51



DE-1158
Fig. 138



DE-1159
Fig. 139



DE-1160
Fig. 200



DE-1161
Fig. 201



DE-1162
Fig. 202



DE-1163
Fig. 203



DE-1164
Fig. 204



DE-1165
Fig. 205



DE-1166
Fig. 3



DE-1167
Fig. W3



DE-1168
Fig. 4



DE-1169
Fig. 56A



DE-1170
Fig. 7



DE-1171
Fig. 7A



DE-1172
Fig. 8



DE-1173
Fig. 8A



DE-1174
Fig. W8A



DE-1175
Fig. 10



DE-1176
Fig. 11



DE-1177
Fig. 12A



DE-1178
Fig. 13A



DE-1179
Fig. 14



DE-1180
Fig. 14A



DE-1181
Fig. 14AN



DE-1182
Fig. 22



DE-1183
Fig. 27



DE-1184
Fig. 207



DE-1185
Fig. 29



DE-1186
Fig. 206



DE-1187
Fig. 208



DE-1188
Fig. 209



DE-1189
Fig. 1



DE-1190
Fig. 1A



DE-1191
Fig. 2



DE-1192
Fig. 2A



DE-1193
Fig. W2A



DE-1194
Fig. 0



DE-1195
Fig. 00



DE-1196
Fig. 210



DE-1197
Fig. 211



DE-1198
Fig. 212



DE-1199
Fig. 6



DE-1199
Fig. 6



DE-1200
Fig. 9



DE-1200
Fig. 9



DE-1201
Fig. N06



DE-1202
Fig. U67



DE-1203
Fig. 214



DE-1204
Fig. P1



DE-1205
Fig. P2



DE-1206
Fig. G-1



DE-1207
Fig. G-2



- Инструменты для удаления коронок
- Arrache-couronnes
- Teleskopkronenzangen
- Инструменты для видалення коронок
- Arranca-corona
- مزيلات التاج



DE-1210
Crown Spreaders



DE-1211
Mershon
14 cm
Band Pusher



DE-1212
Fig. 0



DE-1213
Manual Crown Remover



DE-1214
Complete with 3 tips
and tightening keys

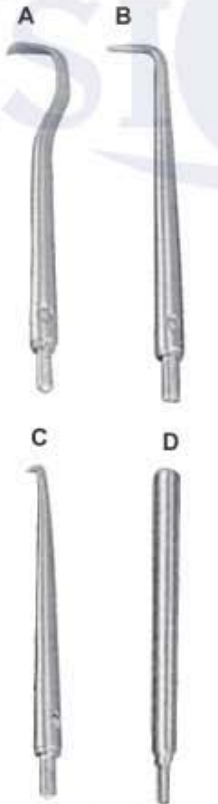

semi-automatic crown
& bridge remover



DE-1215



DE-1216
Manual Crown Remover

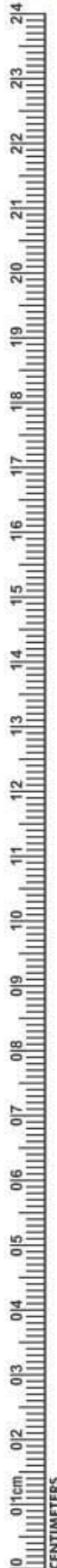

MATRIX RETAINERS



- Матрицедержатели
- Porte Matrices
- Matrizenspanner

- Матрицеутримувачи
- Porta Matrices
- مصفوفة الخدم



DE-1217
Fig. 5
Ivory 8
5 cm



DE-1218
Fig. 6
Ivory 8
6 cm



DE-1219
Fig. 7
Ivory 8
7 cm



DE-1220
Fig. 1
Tofflemire-Universal



DE-1221
Fig. 2
Tofflemire-Junior



DE-1222
Fig. 3
Tofflemire-Senior



DE-1223
Narrow



DE-1224
Wide

Amalgam Well



DE-1225
Stainless Steel
Amalgam Well



DE-1226
Ivory 12



DE-1227
Ivory 1



DE-1228
Ivory



DE-1229
Elliot

Siqveland Retainers



Инструменты для амальгамы
 • Instruments pour amalgame
 • Amalgamis/Instrumente

• Инструменты для амальгами
 • Instrumentos para amalgame
 • الصكوك المشقم

• Ручки для скальпелей
 • Manches de bistouris
 • Skalpelgriffe

• Ручки для скальпелів
 • Mangos de bisturi
 • مشرط مقابض

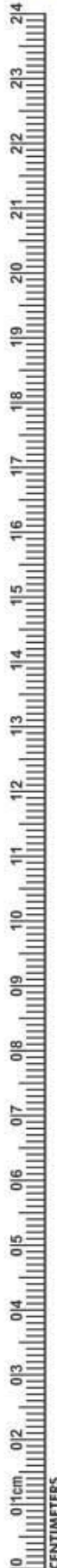

Ø 2mm

DE-1230
 Fig. 10
 165mm
 English pattern



Ø 2mm

DE-1231
 Fig. 1
 185mm
 German pattern



Ø 2mm

DE-1232
 Fig. 1
 150mm
 Swiss pattern



Ø 2mm

DE-1233
 Fig. 1
 150mm



Ø 2mm

DE-1234
 Fig. 2
 150mm, 45°



Ø 2mm

DE-1235
 Fig. 3
 140mm, 90°



DE-1236
 Fig.3
 5" (12.7cm)



DE-1237
 Fig.3G
 5" (12.7cm)



DE-1238
 Fig.4
 5 1/2" (13.7cm)



DE-1239
 6 Way Adjustable Angled
 Scalpel Handle



Locks At 90°, 60°, 30°,
 Straight, 120°, 150°, 180°,
 Angles

- Инструменты для амальгамы
- Instruments pour amalgame
- Amalgamis/instrumente
- Инструменти для амальгами
- Instrumentos para amalgama
- الصكوك الملقم

AMALGAM CARRIERS

DE-1240
Distal
Improves visibility and access to posterior regions.

DE-1241
Single-End

DE-1242
Double-End

TIP SIZES FOR DOUBLE-END

1.5 mm	2.8 mm	3.2 mm
2.0 mm	2.0 mm	2.0 mm
DE-1243 Mini/ Regular	DE-1244 Large/ Regular	DE-1245 Jumbo/ Regular

TIP SIZES FOR DISTAL OR SINGLE-END

1.5 mm	2.0 mm	2.8 mm
DE-1246 Mini/ Single-End	DE-1247 Regular Single-End	DE-1248 Large Single-End

1.5 mm	2.0 mm	
DE-1249 Mini Distal	DE-1250 Regular Distal	DE-1251 Amalgam Well



ROOT PLANNING FILES



DE-1252
Kramer-Nevis
Bone Chisel



DE-1253
Kramer-Nevis
Bone Chisel



DE-1254
Molt 18.5cm
Auto Clavable
Plastic Tips.



DE-1255
Mead 18.5cm
Non Auto Clavable
Plastic Tips.



DE-1256
Miller



DE-1257
Miller

BONE FILES



DE-1258
Miller 21



DE-1259
Miller 1X
cross cut



DE-1260
Miller 2X
cross cut



DE-1261
Miller 52



DE-1262
Wahl 1

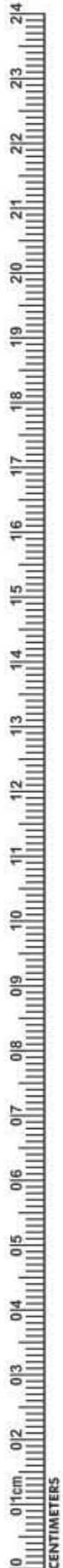

- Инструменты пародонтологические
- Instruments pour la parodontologie
- Instrumente für die Parodontologie
- Инструменти пародонтологічні
- Instrumentos para periodoncia
- الصكوك اللثة

PERIOSTEEL ELEVATORS



DE-1263
BUSER

DE-1264
Ohl 10

DE-1265
Howard 9H

DE-1266
Freer

DE-1267
Freer 15

DE-1268
Freer 16

DE-1269
Molt 9

DE-1270
Allen 9A

DE-1271
Prichard 3



DE-1272
Seldin 23



DE-1273
Goldman-Fox
14



DE-1274
P 24G



DE-1275



DE-127A



DE-127B

Raspator, Raspatory
Length 175 mm,



DE-1276



DE-1276A



DE-1276B

Raspator, Williger
Length 170 mm, different widths
(4 mm, 5 mm or 7 mm),





Behind Every Smile is a Story

- QUALITY - ЯКІСТЬ
- PRECISION - ТОЧНІСТЬ
- ACCURACY - ПРАВИЛЬНІСТЬ
- DURABILITY - ЗНОСОСТІЙКІСТЬ



- Super-sharp diamond bevel cutter
- smooth ultra-polished and chamfered edges
- brilliant corrosion resistant stainless steel finish
- superior T-12 stainless steel tool steels
- sliding lock joint for balance & precision alignment

- Super-sharp diamond bevel cutter
- smooth ultra-polished and chamfered edges
- brilliant corrosion resistant stainless steel finish
- superior T-12 stainless steel tool steels
- sliding lock joint for balance & precision alignment

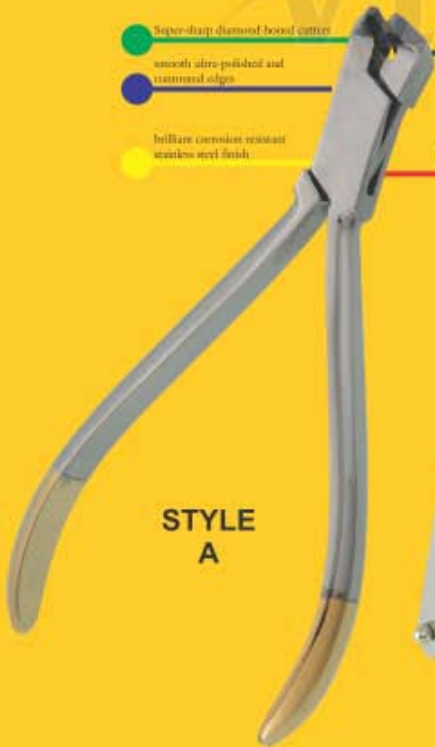

STYLE A



STYLE B

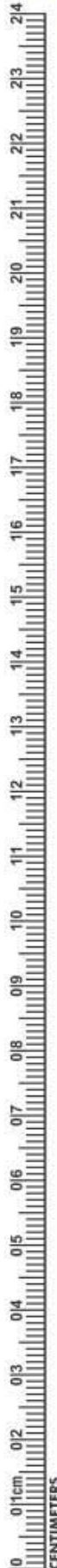

ORTHODONTIC INSTRUMENTS



- Инструменты ортодонтические
- Instrumentos Ortodonticos
- Orthodontische Instrumente
- Инструменти ортодонтични
- Instruments Orthodontiques
- أدوات تقويم الأسنان



DE-1277
Aluminum Height Gauge 0.22



DE-1278
Aluminum Height Gauge 0.18



DE-1279
Bone Bracket Gauge



DE-1280
Bone Thickness Gauge 40mm, 180mm



DE-1281 OSTEOMETER
Measuring Forceps For Jaw Ridge Width measurement, scale on both sides, rustfree, autoclavable



DE-1282
Direct bonding bracket holders, 135mm



DE-1283
Deluxe Bracket Holder Tweezers



DE-1284
Direct bonding bracket holders, 136mm



DE-1285
Direct Bond Bracket Holder Tweezers, Small Tip



DE-1286
Direct bonding bracket holders, 140mm



DE-1287
Direct bonding bracket holders, 135mm



DE-1288
Direct Bonding Bracket Holders, 140mm



- Инструменты ортодонтические
- Instrumentos Ortodonticos
- Orthodontische Instrumente
- Инструменти ортодонтични
- Instruments Orthodontiques
- أدوات تقويم الأسنان



DE-1289
Band seater auto cleavable



DE-1290
Ortho light scaler double ended



DE-1291
Ortho light scaler double ended



DE-1292
Ortho light scaler double ended



DE-1293
Twiel-on elastic module instrument



DE-1294
Twiel-on elastic module instrument



DE-1295
Schure Band Seater



DE-1296
Ortho light scaler



DE-1297
Ortho light scaler



DE-1298
Ortho light scaler heavy



DE-1299
Ortho instrument



DE-1300
Ortho instrument



DE-1301
Ortho Light Band Pusher Scaler

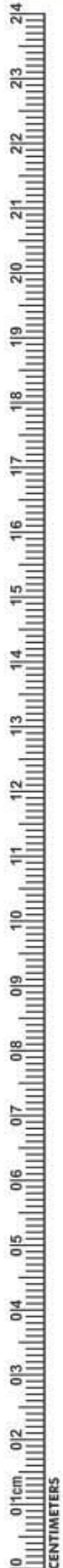

ORTHODONTIC INSTRUMENTS



- Инструменты ортодонтические
- Instrumentos Ortodonticos
- Orthodontische Instrumente
- Инструменти ортодонтични
- Instruments Orthodontiques
- أدوات تلويح الأسنان



DE-1302
Ortho Light double ended
ligature director



DE-1303
Ortho Light double ended
ligature director scaler



DE-1304
Ortho Light double ended ligature scaler director tivate coil spring
are remove modules with one instruments



DE-1305
Ortho band pusher scaler



DE-1306
Ortho Light Band Pusher Scaler



DE-1307
Ortho ligature director single ended

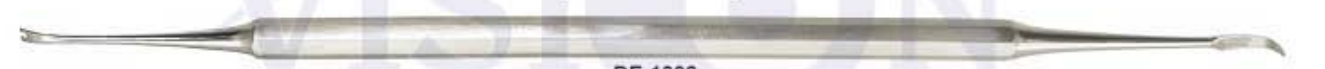

DE-1308
Ortho Light double ended ligature
director scaler



DE-1309
Ortho Light double ended ligature scaler/director
tivate coil spring are remove modules with one instruments



DE-1310
Ortho Light double ended ligature director



DE-1311
Ortholite Ligature Director Scaler



DE-1312
Ortho light ligature director double ended



DE-1313
Double ended cement spatula



DE-1314
Ortho light scaler single ended



- Щипцы для ортодонтии и протезирования
- Pincers pour l'orthodontie et la prothèse
- Zangen für Kieferorthopädie und Prothetik

- Щипці для ортодонції та протезування
- Alicates para ortodoncia y prótesis
- كمشة لتقويم الأسنان بروتستیس

BOX JOINT PLIERS

DE-1315
Universal Dolphin Style
Wire Bending & cutting pliers



DE-1316 Band Removing Plier
The curved blade of the band removing plier can strip easily and gently remove directly to the tooth. Length 130mm



DE-1317
Tweed Loop forming Pliers



DE-1318
How Plier curved
Universally usable tool for the multiband technology for wires up to .028". Length 130mm



DE-1319 How Plier
Universally usable tool for the multiband technology for wires up to .028". Length 135mm



DE-1320
Nance Loop forming Pliers



DE-1321
Bracket Removing Plier curved
Bracket Removing Plier curved for easy removal of brackets in the posterior region. Length 130mm



DE-1322
Young Wire Bending & Loop Forming Pliers



DE-1323
Wire Bending & Loop Forming Pliers



DE-1324
Adams, small wire bending and loop forming Pliers



DE-1325
Bracket Removing Plier Round Box
Bracket removing plier for comfortable and quick removal of the brackets. Length 135mm



DE-1326
Weingart Plier medium
Weingart plier that are ideal due to their curved tip for setting sheets and is capable of bending the ends. Length 145mm

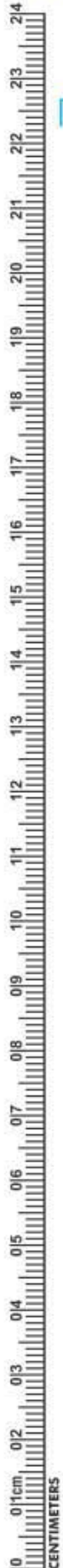

PLIERS FOR ORTHODONTICS & PROSTHETICS



- Щипцы для ортодонтии и протезирования
- Pincers pour l'orthodontie et la prothèse
- Zangen für Kieferorthopädie und Prothetik
- Щипці для ортодонції та протезування
- Alicates para ortodoncia y prótesis
- كمامة لتقويم الأسنان بروستیتیس

BOX JOINT PLIERS

DE-1327 Adams Plier Round Box

Adams pliers for bending wire arches and bends right angles for wires up to .022", .025 tip to beak. Length 125mm

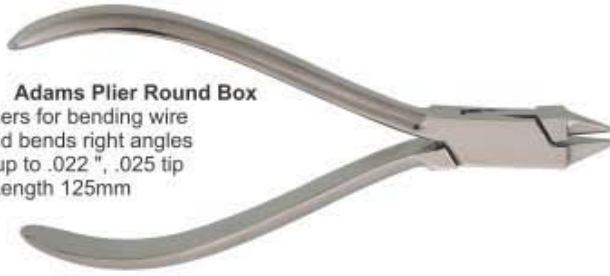

DE-1333 Adams Plier

Adams pliers for bending wire arches and bends right angles for wires up to .022", .025 tip to beak. Length 125mm



DE-1328

Falcon Beak Contouring Pliers.



DE-1334

Tweed Loop Formin Pliers



DE-1329

wires up to 0.020" / 0.7mm.



DE-1335 Bird Beak Plier Standard

Bird Beak Wire bending plier without notches, which is suitable as a universal utility tool. Length 125mm



DE-1330

Johnson Contouring Pliers



DE-1336

Mini Ligature cutters



DE-1331 Aderer

Large wire bending and loop forming pliers



DE-1337 Small

Fluch-cut distal and cutting Pliers with safety hold fitted with un-breakable, corrosion resistant and durable stainless steel tips



DE-1332

Tweed / angle rectangular arch forming & Torquing pliers



DE-1338 Large

Fluch-cut distal and cutting Pliers with safety hold fitted with un-breakable, corrosion resistant and durable stainless steel tips



- Щипцы для ортодонтии и протезирования
- Pincers pour l'orthodontie et la prothèse
- Zangen für Kieferorthopädie und Prothetik

- Щипці для ортодонції та протезування
- Alicates para ortodoncia y prótesis
- كمشة لتقويم الأسنان بروتستیس

BOX JOINT PLIERS

DE-1339
Tweed / Angel
1.78mm (.070") wide tips arch
forming and torquing pliers



DE-1345
Contouring Plier



DE-1340
Tweed / Angel
1.78mm (.070") wide tips arch
forming and torquing pliers



DE-1346
Bands & Crowns Plier
in order to skirt



DE-1341
Lingual / Palatal arch
forming pliers



DE-1347
Ligature Forming Pliers



DE-1342
Aderer
Facebow loop forming Pliers



DE-1348
for double back and triple back
bands in 0.30" / 0.76mm & 0.36"
/ 0.91mm lingual arch wires



DE-1343
Waldsavs wire bending
and cutting pliers



DE-1349
Bird Beak Wire Bending
& cutting pliers



DE-1344 Aderer Plier
For the manufacturing of appliances and
activation of wires for wires up to .030" .fine
tip and up to .036" mean tip.
Length 130mm



DE-1350
Weingart Plier medium
Weingart plier that are ideal due to
their curved tip for setting sheets and
is capable of bending the ends.
Length 145mm

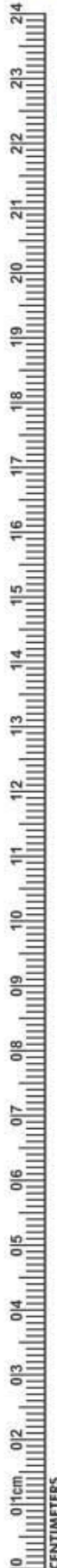

- Щипцы для ортодонтии и протезирования
- Pincers pour l'orthodontie et la prothèse
- Zangen für Kieferorthopädie und Prothetik
- Щипці для ортодонції та протезування
- Alicates para ortodoncia y prótesis
- كاشطة لتقويم الأسنان بروستتیس

LAP JOINT PLIERS



DE-1351
Distal End Cutter
Regular with T.C

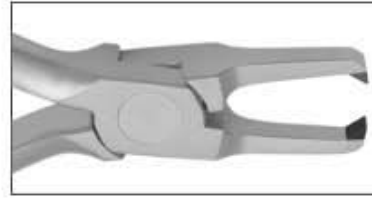

DE-1358
Bracket Remover Pliers
Straight With T.C



DE-1352
Hard Wire Cutter With T.C



DE-1359
Bird Beak Plier With TC



DE-1353
Ligature Cutter Angled
15° With T.C

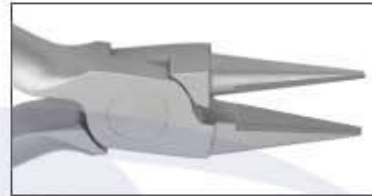

DE-1360
Light Wire Bird Beak
Long Plier With TC



DE-1354
Light Wire Cutter Micro
With T.C



DE-1361
Adam Plier With TC



DE-1355
Reversed Ligature
Cutter Angled
40° With T.C



DE-1362
Tweed Arch Forming Plier
1.78mm With TC



DE-1356
Posterior Band Remover Pliers
Long With T.C



DE-1363
Weingart Plier Slim
With TC



DE-1357
Posterior Band Remover Pliers
Medium With T.C

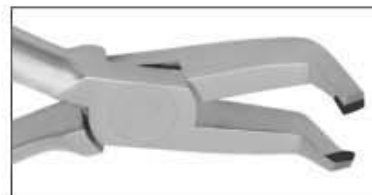

DE-1364
Bracket Remover Pliers
Angled With T.C



- Щипцы для ортодонтии и протезирования
- Pincers pour l'orthodontie et la prothèse
- Zangen für Kieferorthopädie und Prothetik
- Щипці для ортодонції та протезування
- Alicates para ortodoncia y prótesis
- كمشة لتقويم الأسنان بروتستیس

LAP JOINT PLIERS

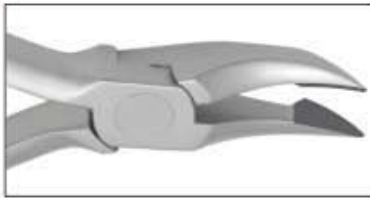

DE-1365
Weingart Plier Regular
With TC

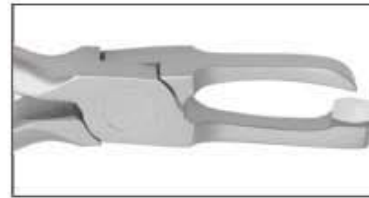

DE-1372
Posterior Bend Remover
Plier Long

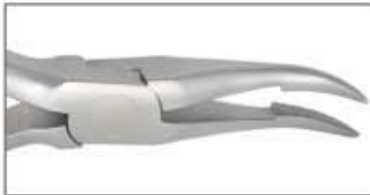

DE-1366
Weingart General Utility Plier
Long Mouth With TC

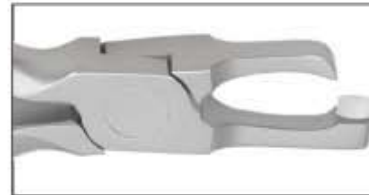

DE-1373
Posterior Bend Remover
Plier Short

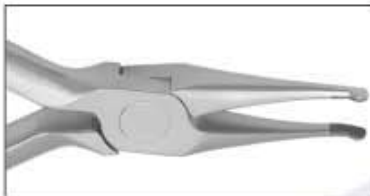

DE-1367
How Plier Straight
With TC



DE-1374
Posterior Bend Remover
Plier Medium

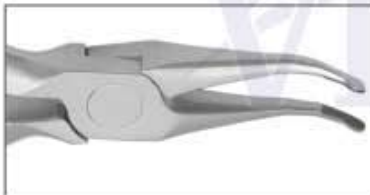

DE-1368
How Plier Curved
With TC

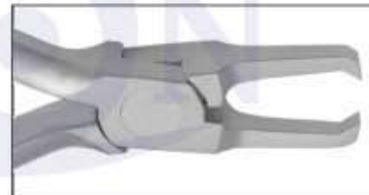

DE-1375
Bracket Remover Plier
Straight



DE-1369
Step Pliers with T.C
0.5mm

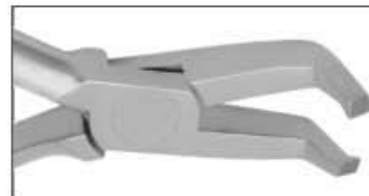

DE-1376
Bracket Remover
Angulated
Plier



DE-1370
Weingart Plier Utility
With TC

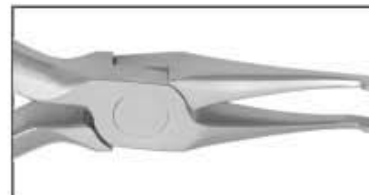

DE-1377
How Plier Straight

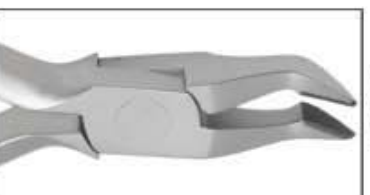

DE-1371
Weingart Plier Universal
With TC 45°



DE-1378
Bird Beak Angled
Bending Plier

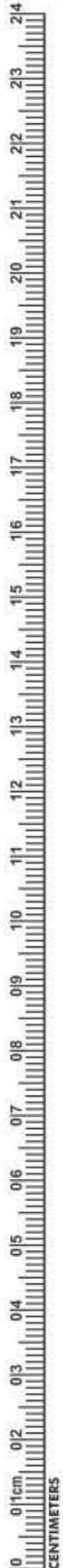

PLIERS FOR ORTHODONTICS & PROSTHETICS



- Щипцы для ортодонтии и протезирования
- Pincers pour l'orthodontie et la prothèse
- Zangen für Kieferorthopädie und Prothetik
- Щипці для ортодонції та протезування
- Alicates para ortodoncia y prótesis
- كمامة لتقويم الأسنان بروستیتیس

LAP JOINT PLIERS

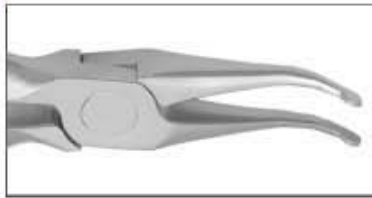

DE-1379
How Plier Curved



DE-1386
Tweed Cutter Plier With Groove



DE-1380
Hammer Head Tie Back Plier



DE-1387
Round Nose Plier



DE-1381
Arch Forming Pliers



DE-1388
Adam Plier



DE-1382
Regular Tweed Arch Forming Pliers 1.78mm



DE-1389
Jara Beak Plier



DE-1383
Bird Beak with Cutter Pliers 3 Groove



DE-1390
Band Seating Plier



DE-1384
Light Wire Bird Beak Pliers With Groove

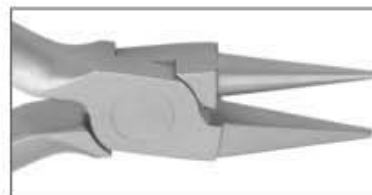

DE-1391
Light Wire Bird Beak Long Plier



DE-1385
Tweed Loop Plier



DE-1392
Light Wire plier two step groove 0.51mm/.020"



- Щипцы для ортодонтии и протезирования
- Pincers pour l'orthodontie et la prothèse
- Zangen für Kieferorthopädie und Prothetik
- Щипці для ортодонтії та протезування
- Alicates para ortodoncia y prótesis
- كمشة لتقويم الأسنان بروستیتس

LAP JOINT PLIERS



DE-1393
Ball Hook Crimping Plier



DE-1394
Marcotte Looping Plier



DE-1395
Tweed Loop Plier

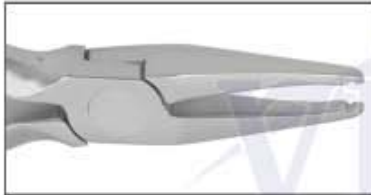

DE-1396
Palatal Arch Plier

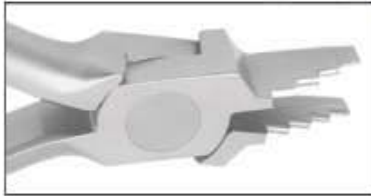

DE-1397
Nance Plier



DE-1398
Young Plier with Grooved



DE-1399
Wingurt Plier Slim



DE-1400
Tweed loop Forming
Plier TC.



DE-1401
Wingurt Utility Plier

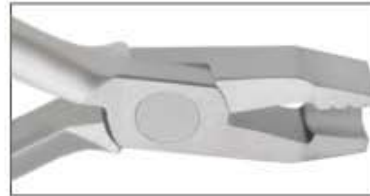

DE-1402
De La Rosa Pliers
with Grooved



DE-1403
De La Rosa Pliers



DE-1404
Crown and Band
Contouring Pliers



DE-1405
Flat Nose Plier with Serration



DE-1406
Flat Nose Plier Smooth



DE-1407
Stop V Bending Plier



PLIERS FOR ORTHODONTICS & PROSTHETICS



- Щипцы для ортодонтии и протезирования
- Pincers pour l'orthodontie et la prothèse
- Zangen für Kieferorthopädie und Prothetik
- Щипці для ортодонції та протезування
- Alicates para ortodoncia y prótesis
- كمامة لتقويم الأسنان بروستتیس

LAP & L-KEY JOINT PLIERS



DE-1408
Hollowchop Contouring
Pliers



DE-1409
Lap-Joint Three Prong Plier



DE-1410
Three Prong Pliers Regular



DE-1411
Lingual Plier Weingart
Regular Long Handle 35°



DE-1412
Lingual Plier Long Handle
90° Angled

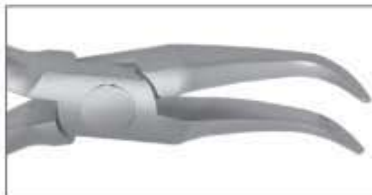

DE-1413
Lingual Weingart Plier Fine
Long Handle 60° Angled



DE-1414
Direct Bonding Bracket
Remover Plier TC.



DE-1415
Pin & Ligature Cutters
TC.



DE-1416
Mini Pin & Ligature
Cutter TC.



DE-1417
Standard Ligature
Cutter TC.



DE-1418
V Bend Stop Plier
TC.



DE-1419
Angled Direct Bond Bracket
Remover TC.



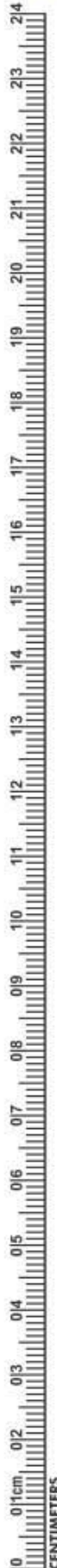

DE-1420
Distal end Cutter, Safety Hold Plier
(Ideal for Cutting Wire) TC.



DE-1421
Hook Crimping Plier Angled
Straight TC.



DE-1422
3 Prong Clasp Adjustable
Plier TC.



DE-1423
Utility Plier Weingart TC.



DE-1424
Direct Bracket Remover
TC.



DE-1425
Straight Direct Bond Bracket
Remover TC.



DE-1426
Pin Holding Plier TC.



DE-1427
Hard wire cutters



DE-1428
Elastic Separating Plier
Round Handle



DE-1429
Elastic
Separating Plier



DE-1430
DE-1431
Smaha
Elastomeric
ligature
placing forceps
140 mm



DE-1432
Elastomeric
ligature placing
forceps with
groove
Falcon 140 mm



DE-1433
Elastomeric
ligature placing
forceps with
groove
Falcon 140 mm



Normal Anatomy – Dental Implants

Bone Level Normal
(No Bone Loss)

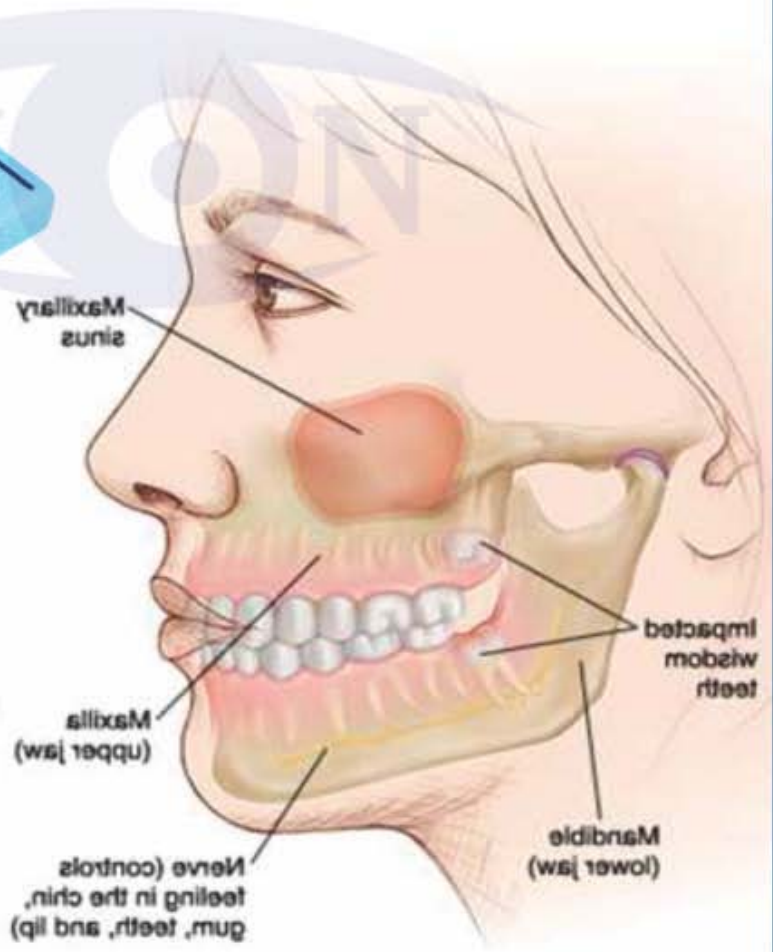
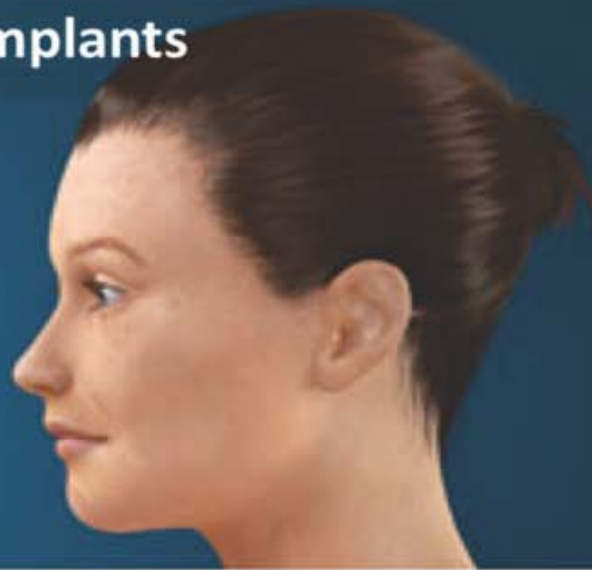
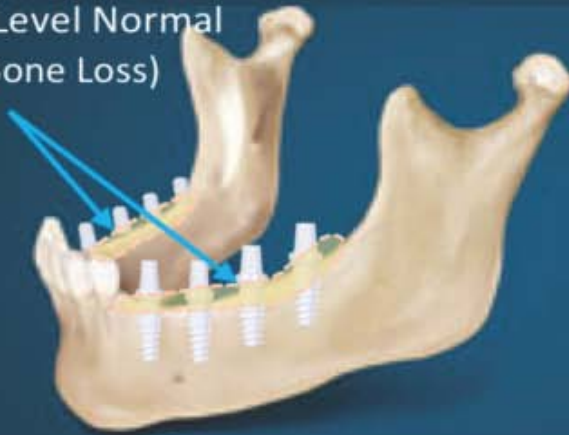

- Инструменты для имплантологии
- Implantologie
- Implantologie

- Інструменти для імплантології
- Implantologia
- زراعة الأسنان

IMPLANT GAGES



DE-1434
Multifunctional Meter
 Length 90 mm,
 different sizes,
 8-10-11mm,
 corrosion-resistant

DE-1435
Multifunctional Meter
 Length 90 mm,
 different sizes,
 5-13-15-17 mm,
 corrosion-resistant

DE-1436
Measuring Probe
 Length 170 mm,
 hand shape or flexible
 (6-8-10-14-16 mm),
 corrosion-resistant

DE-1437

DE-1438

DE-1439

DE-1440

IMPLANT GAGES



DE-1441

DE-1442

DE-1443

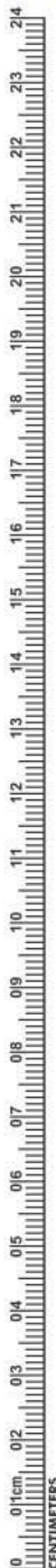

- Инструменты для имплантологии
- Implantologie
- Implantologie
- Инструменти для імплантології
- Implantoloia
- زراعة الأسنان



DE-1444
Clamp, Osteometer
 Length about 155 mm,
 ridge width measurement,
 two-sided scale,
 measuring
 range 0 - 25 mm



DE-1445
Measuring Loop
 straight length 90 mm,
 measuring range
 0 - 40 mm,



DE-1446
Measuring Loop
 angled, length 90 mm,
 measuring range
 0 - 40 mm,



DE-1447
Measuring loop, Castroviejo
 angled, length 175 mm,
 measuring range 0 - 40 mm,
 with window



DE-1448
Boley Gauge
 Stainless Steel



DE-1449
Measuring Loop
 angled, length
 175 mm,
 measuring range
 0 - 40 mm,



DE-1450
Measuring Loop
 straight length
 175 mm,
 measuring range
 0 - 40 mm,



DE-1451
 Fig. 1
 Iwanson
 spring caliper
 For metal and
 porcelain.



DE-1452
 Fig. 2
 Iwanson
 spring caliper
 For wax.



DE-1453
Bone Thickness Gauge
 40mm, 180mm



DE-1454
Gauge
 for measuring
 distances
 (0 - 90 mm),



- Инструменты для имплантологии
- Implantologie
- Implantologie

- Інструменти для імплантології
- Implantologia
- زراعة الأسنان

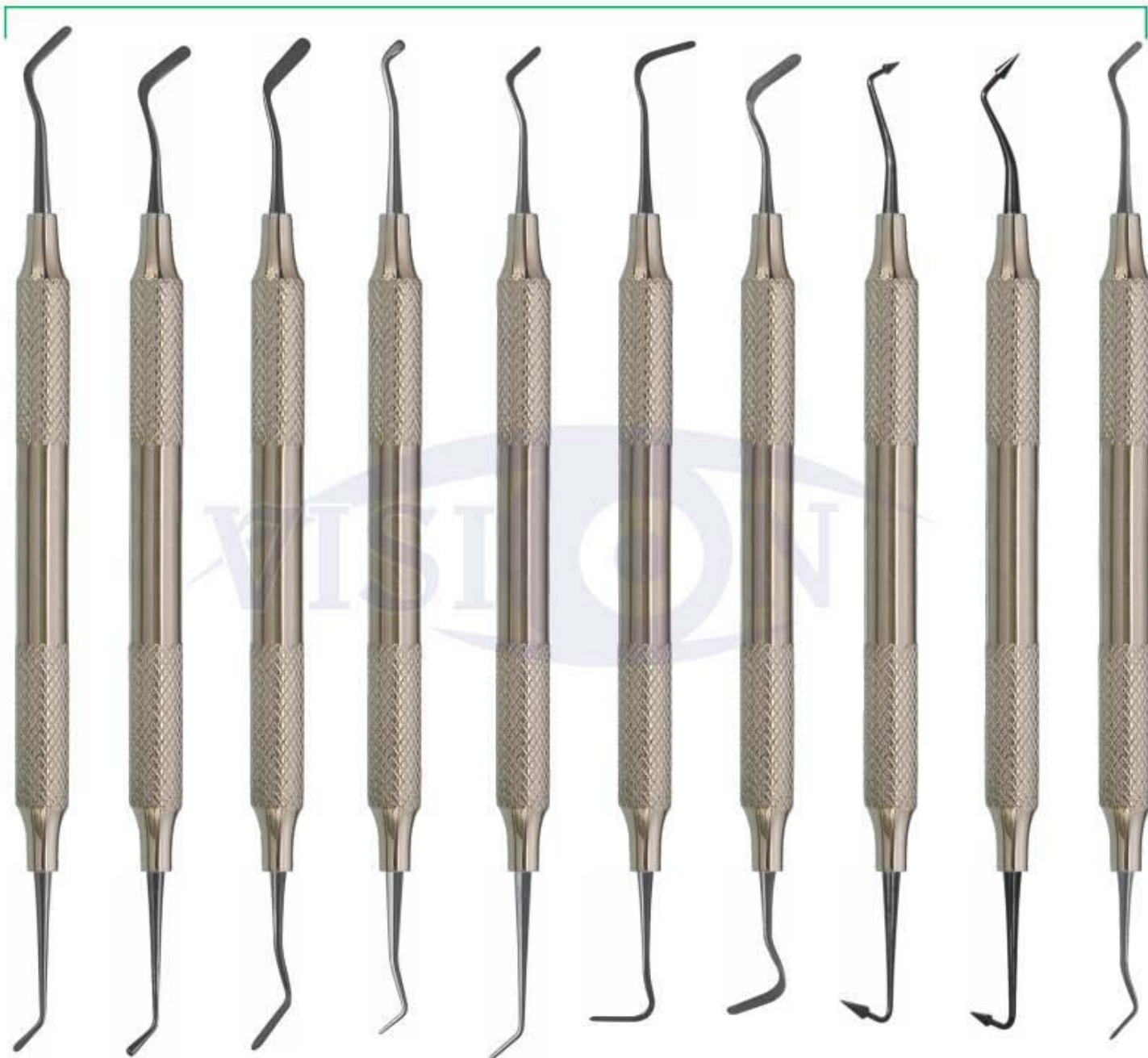
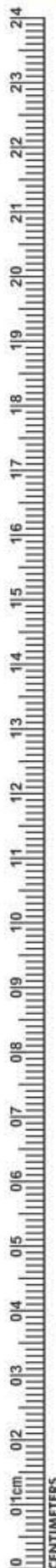
BLACK TITANIUM COLOUR COATED INSTRUMENTS

DE-1455 #1	DE-1456 #2	DE-1457 #3 Extra-Flex	DE-1458 Micro-Mini	DE-1459 Mini 1	DE-1460 Mini 4 Extra-Flex	DE-1461 #4 Extra-Flex	DE-1462 #5 Flexi-Thin	DE-1463 #6 Flexi-Thin	DE-1464 Mini 3 Extra-Flex
----------------------	----------------------	------------------------------------	------------------------------	--------------------------	--	------------------------------------	------------------------------------	------------------------------------	--

- Инструменты для имплантологии
- Implantologie
- Implantologie
- Инструменти для імплантології
- Implantoloia
- زراعة الأسنان

BLACK TITANIUM COLOUR COATED INSTRUMENTS

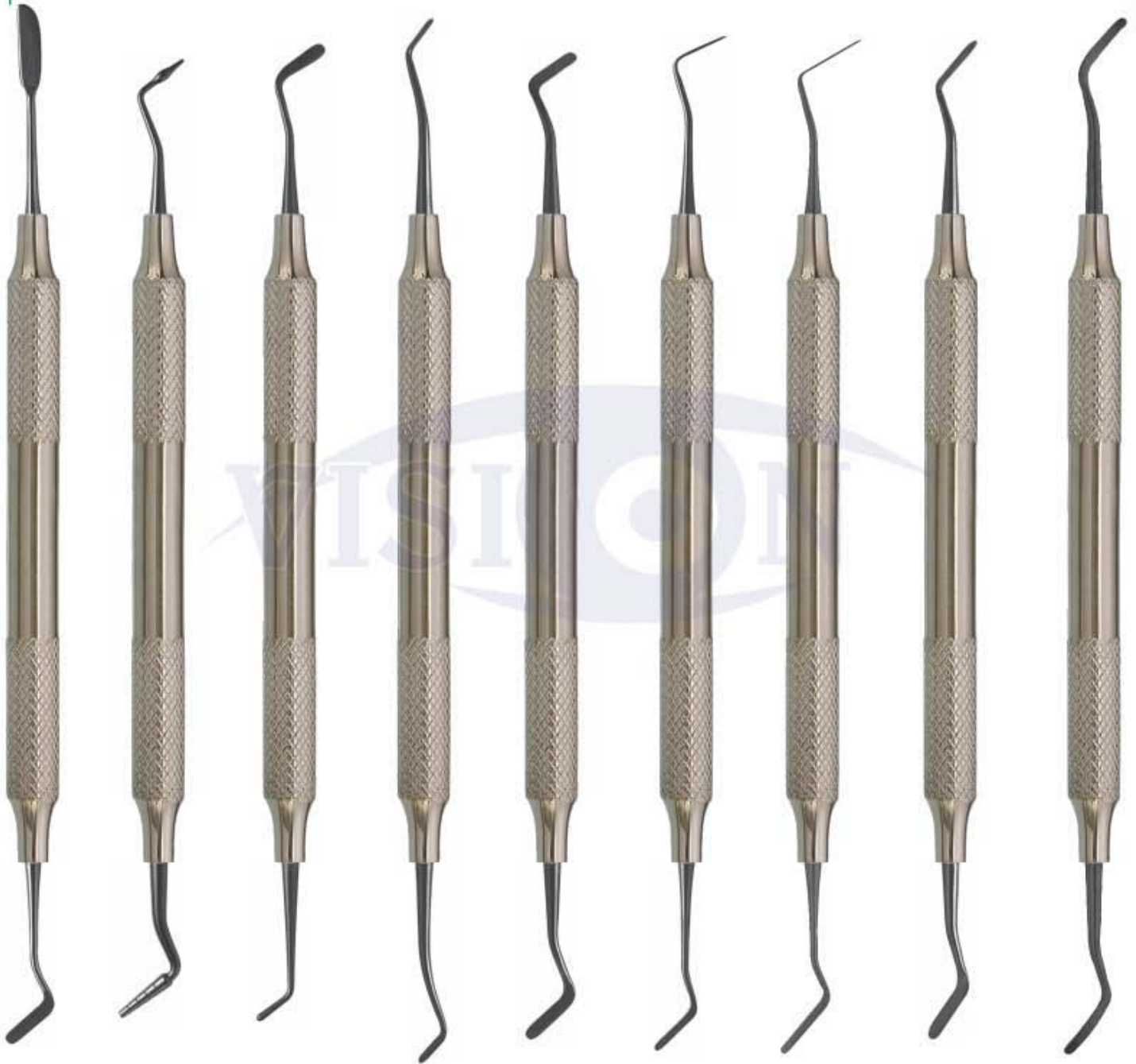

DE-1465
AB1
Boghosian

DE-1466
AB2
Boghosian

DE-1467
W3

DE-1468
8A

DE-1469
4/5
Gregg

DE-1470
Interproximal
Carver

DE-1471
Interproximal
Carver, Long

DE-1472
A6

DE-1473
Contouring
instrument



- Инструменты для имплантологии
- Implantologie
- Implantologie

- Інструменти для імплантології
- Implantologia
- زراعة الأسنان

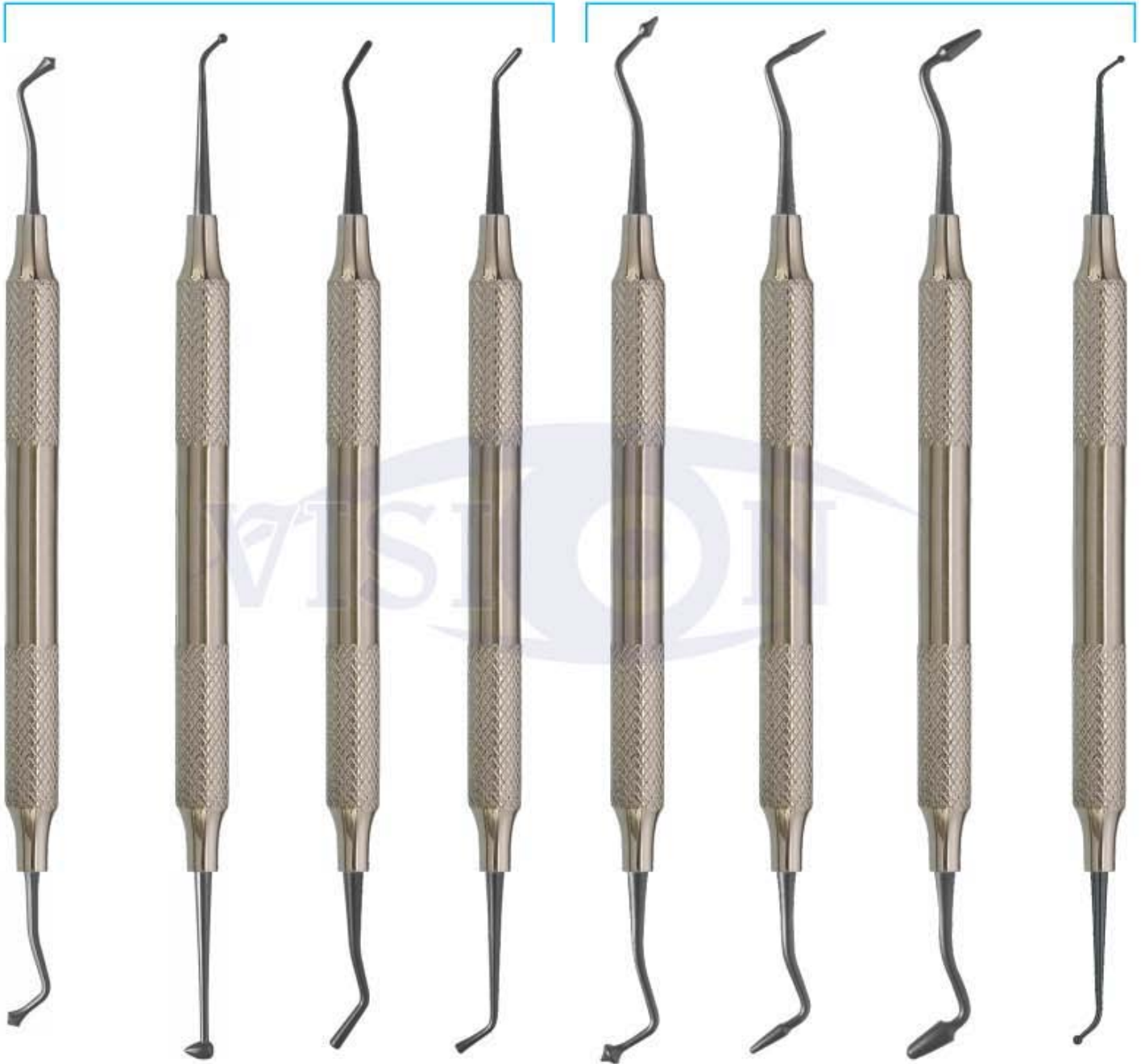
BLACK TITANIUM COLOUR COATED INSTRUMENTS
BURNISHERS
FREEDMAN BURNISHERS

DE-1474
21B

DE-1475
27/29

DE-1476
2
Ladmore

DE-1477
3
Ladmore

DE-1478
Freedman
"Duckhead"

DE-1479
Freedman
Small Contact
Forming

DE-1480
Freedman
Large Contact
Forming

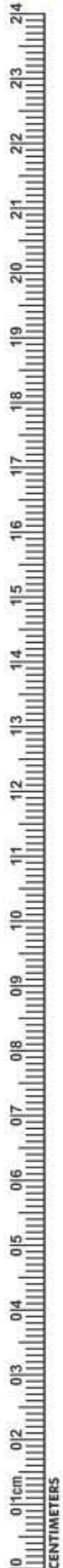
DE-1481
Small/
Medium Ball
Burnisher

- Инструменты для имплантологии
- Implantologie
- Implantologie
- Инструменти для імплантології
- Implantologia
- زراعة الأسنان

BLACK TITANIUM COLOUR COATED INSTRUMENTS

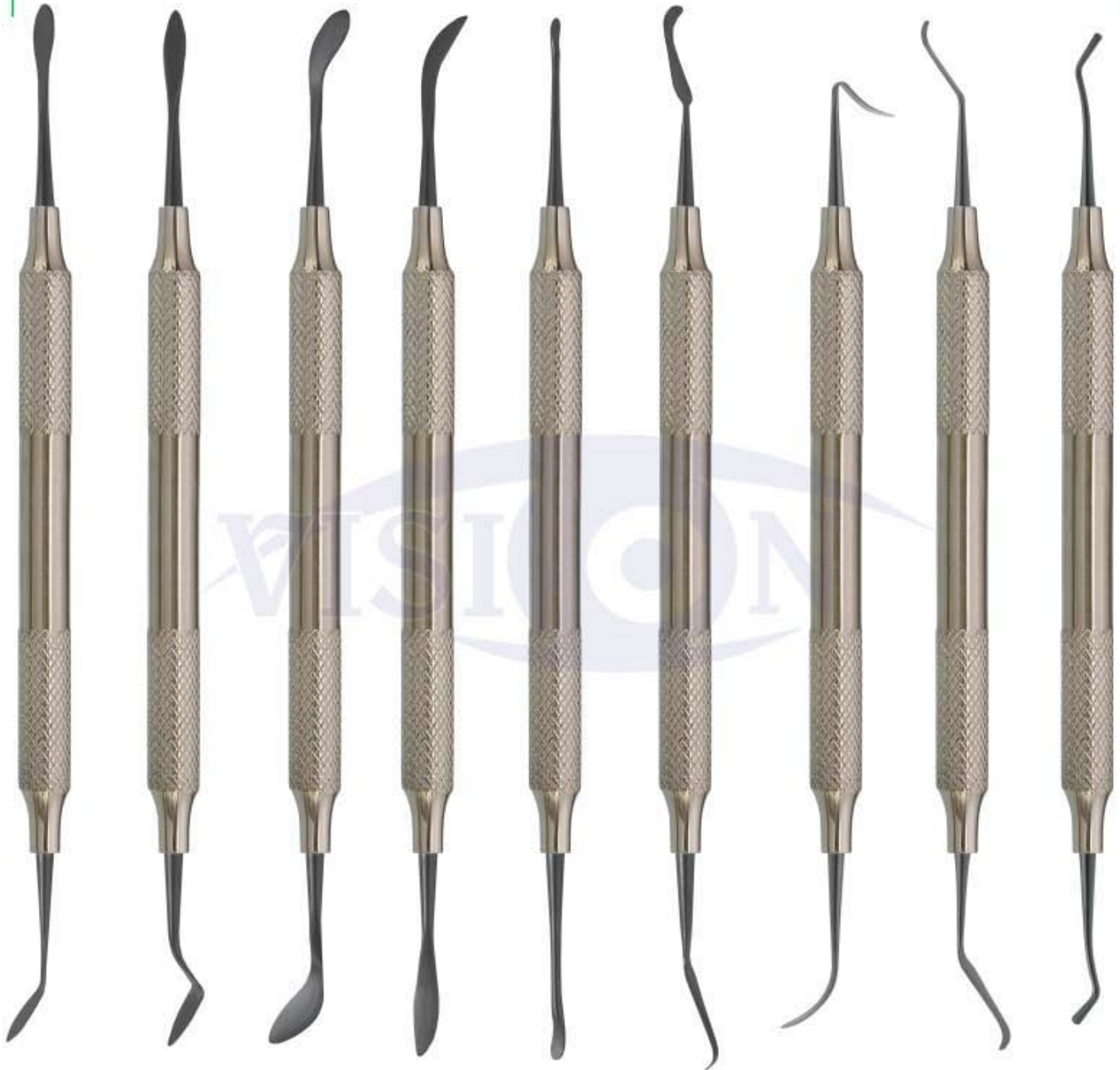

DE-1482
A
Cosmetic
Contouring

DE-1483
B
Cosmetic
Contouring

DE-1484
C
Cosmetic
Contouring

DE-1485
D
Cosmetic
Contouring

DE-1486
E
Cosmetic
Contouring

DE-1487
F
Cosmetic
Contouring

DE-1488
Marginal Ridge
& Embrasure
Shaping Instrument

DE-1489
Occlusal
Anatomy
Instrument

DE-1490
Composite
Packing
Instrument

- Инструменты для имплантологии
- Implantologie
- Implantologie

- Інструменти для імплантології
- Implantologia
- زراعة الأسنان

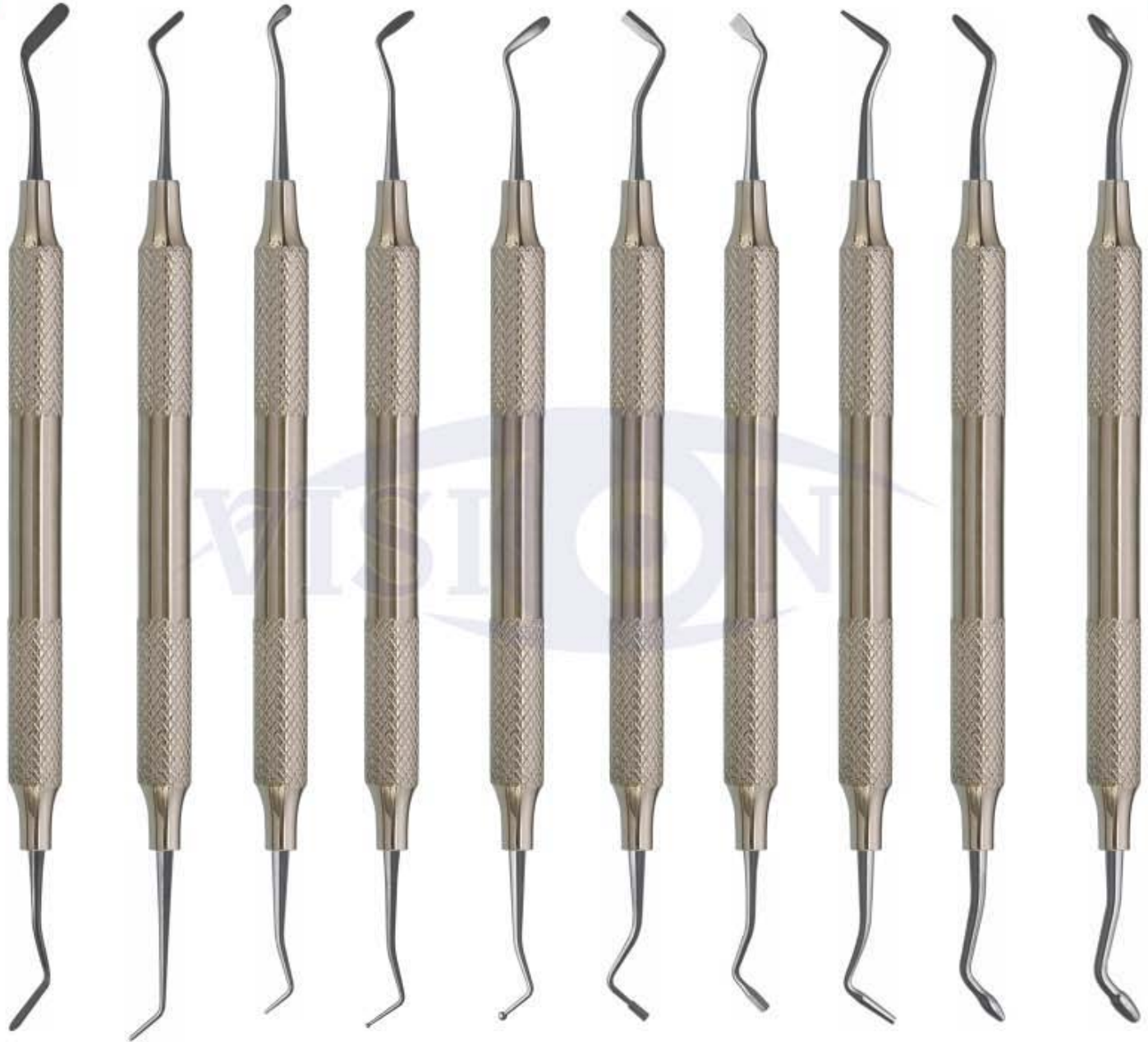
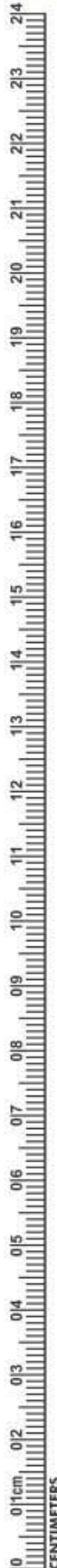
BLACK TITANIUM COLOUR COATED INSTRUMENTS

DE-1491 #3 Extra-Flex	DE-1492 Mini 1	DE-1493 Micro-Mini	DE-1494 Medium Placing/ Condensing	DE-1495 Large Placing/ Condensing	DE-1496 OT Tanner	DE-1497 3 Hollenback	DE-1498 5A	DE-1499 Small/Medium Contact Forming	DE-1500 Medium/Large Contact Forming
------------------------------------	--------------------------	------------------------------	--	---	--------------------------------	-----------------------------------	----------------------	--	--

- Инструменты для имплантологии
- Instrumente für Implantologie
- Implantsologie
- زراعة الأسنان

SINUS LIFT INSTRUMENTS HOLLOW HANDLE 9.5MM LENGTH 170MM



DE-1501
Sinus Lift Elevator

DE-1502
Sinus Lift Elevator

DE-1503
Sinus Lift Elevator

DE-1504
Sinus Lift Elevator

DE-1505
Sinus Lift Elevator



- Инструменты для имплантологии
- Implantologie
- Implantologie
- Инструменти для імплантології
- Implantologia
- زراعة الأسنان

SINUS LIFT INSTRUMENTS HOLLOW HANDLE 9.5MM LENGTH 170MM



DE-1506
Sinus Lift Elevator

DE-1507
Sinus Lift Elevator

DE-1508
Sinus Lift Elevator

DE-1509
Sinus Lift Elevator

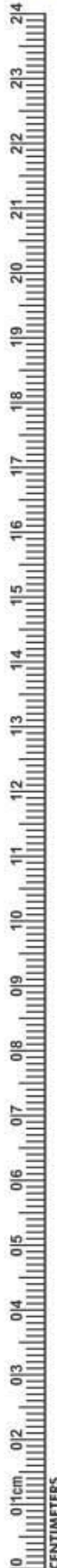

- Инструменты для имплантологии
- Implantologie
- Implantologie
- Инструменти для імплантології
- Implantologia
- زراعة الأسنان

IMPLANT SINUS LIFT INSTRUMENTS HOLLOW HANDLE 9.5MM LENGTH 170MM



DE-1510
Acute 6577

DE-1511
Sinus1

DE-1512
Sinus2

DE-1513
Sinus3,
Obtuse 6578

DE-1514
Sinus4

DE-1515
Sinus5

DE-1516
Sinus6

DE-1517
Sinus7

- Инструменты для имплантологии
 - Implantologie
 - Implantologie
- Інструменти для імплантології
 - Implantologia
 - زراعة الأسنان

SINUS LIFT INSTRUMENTS HOLLOW HANDLE 9.5MM LENGTH 170MM

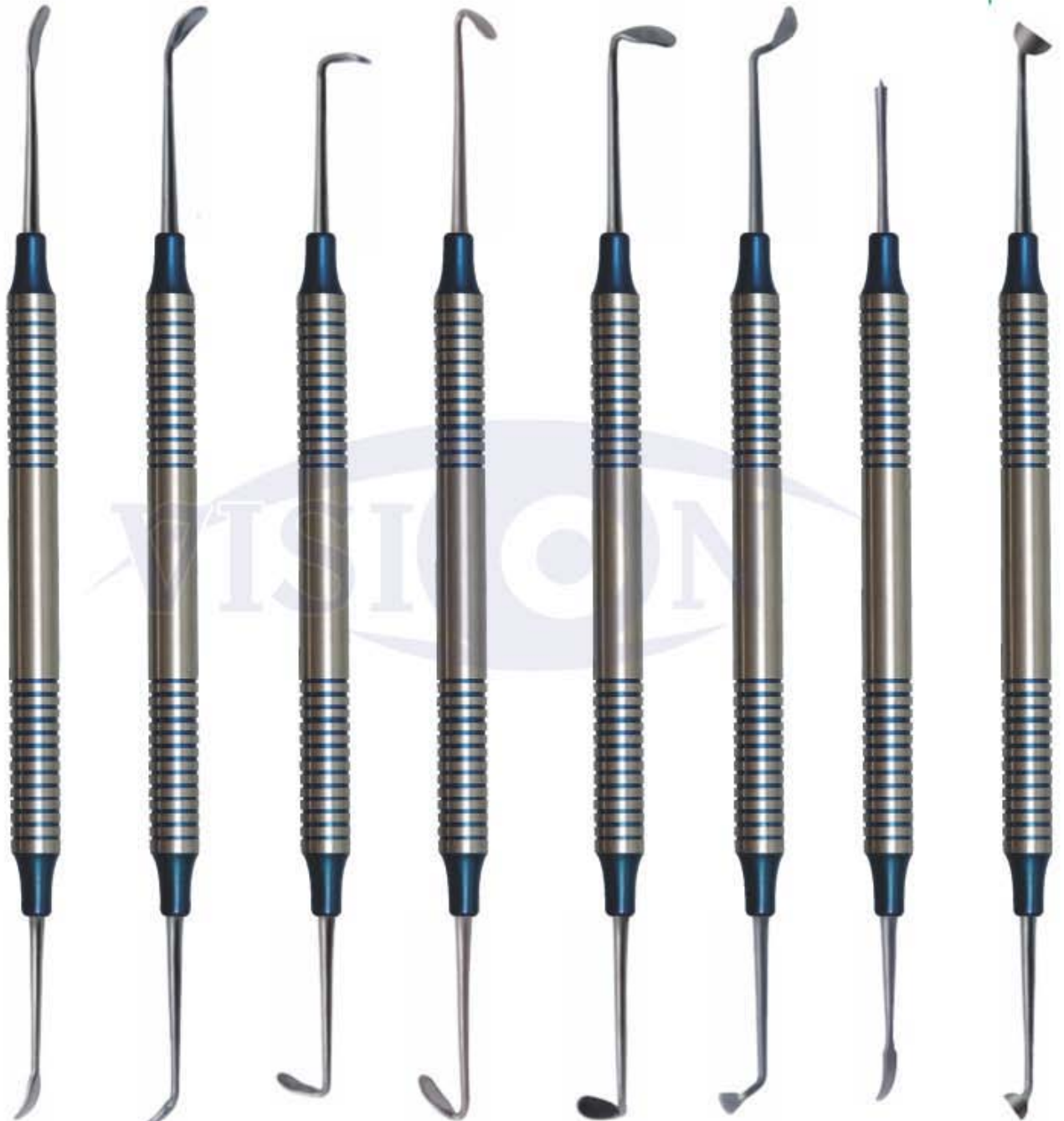
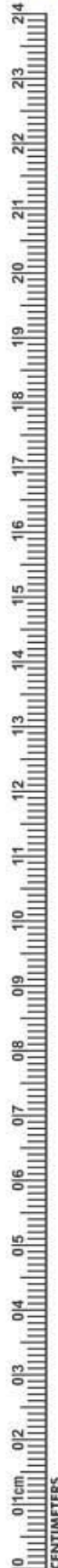

DE-1518 Sinuslift 1	DE-1519 Sinuslift 2	DE-1520 Sinuslift 3	DE-1521 Sinuslift 4	DE-1522 Sinuslift 5	DE-1523 Sinuslift 6	DE-1524 Membrane 3Positioning 1	DE-1525 Condenser 1
-------------------------------	-------------------------------	-------------------------------	-------------------------------	-------------------------------	-------------------------------	--	-------------------------------

- Инструменты для имплантологии
- Implantologie
- Implantologie

- Инструменти для імплантології
- Implantologia
- زراعة الأسنان

Sinus Lift Instrument,
Flexible Sinus Lift instruments
reduce the risk of perforation of the
"Schneider's membrane"



DE-1526
Fig. 1

DE-1527
Fig. 2

DE-1528
Fig. 3

Sinus Lift Elevator,
10 mm Straight grip
Length 175 mm, Sinus lift elevators, dull,
for gentle peeling and lifting the
Schneider membrane



DE-1529
Fig. 1

DE-1530
Fig. 2

DE-1531
Fig. 3

Sinus lift instrument
10 mm Straight grip Length 180 mm,
Buser (B1, B2, B3) raspatories,
quality medical stainless steel,
corrosion-resistant



DE-1532
B01

DE-1533
B02

DE-1534
B03



- Инструменты для имплантологии
- Implantologie
- Implantologia
- زراعة الأسنان

Sinus lift instrument 10 mm Straight grip Sinus lift elevators, blunt or sharply curved
(H01, H02, K03, K04, K78, K77)

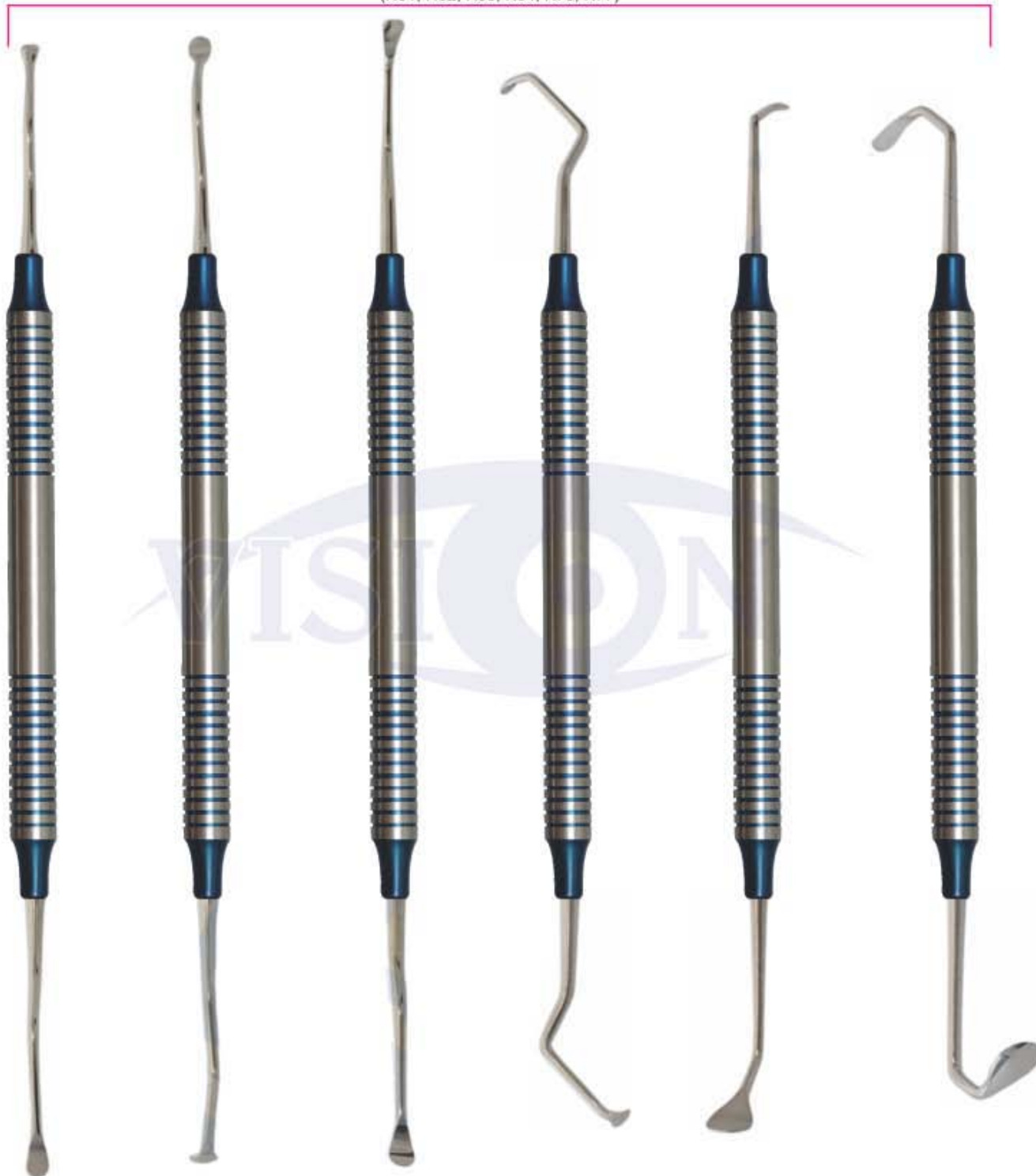

DE-1535
Sinus lift
instrument
H01

DE-1536
Sinus lift
instrument
H02

DE-1537
Sinus lift
instrument
K03

DE-1538
Sinus lift
instrument
K04

DE-1539
Sinus lift
instrument
K78

DE-1540
Sinus lift
instrument
K77

- Инструменты для имплантологии
- Instrumentologie
- Implantologie
- Инструменти для імплантології
- Implantologia
- زراعة الأسنان

SINUS LIFT INSTRUMENT

Sinus Lift Elevators, 10 mm Hollow Handle length 170mm Blunt Curved Set of 6 Pcs



DE-1541

DE-1542

DE-1543

DE-1544

DE-1545

DE-1546



- Инструменты для имплантологии
- Implantologie
- Implantologie

- Інструменти для імплантології
- Implantologia
- زراعة الأسنان

IMPLANT SINUS LIFT INSTRUMENTS
 PERIODONTAL SURGERY SURGICAL CHISELS
 KRAMER NEVINS SINUS LIFT



DE-1547 TG



DE-1548 SOLT3/4



DE-1549 TGO



DE-1550 29K



DE-1551 FEDI4



DE-1552 OCH3



DE-1553 OCH4



DE-1554 FEDI1



DE-1555 FEDI2



DE-1556 FEDI3



DE-1557 Gf36

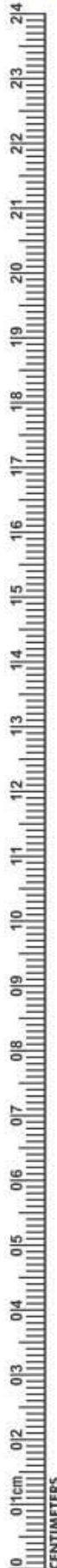

- Инструменты для имплантологии
- Implantologie
- Implantologie

- Інструменти для імплантології
- Implantoloia
- زراعة الأسنان

IMPLANT

SURGICAL CHISELS



- Инструменты для имплантологии
- Implantologie
- Implantologie

- Інструменти для імплантології
- Implantologia
- زراعة الأسنان

MIXING SPATULA WITH SHOVEL

DE-1568
Bone Carrier
Titanium



DE-1569
Raspator, Prichard
Length 180 mm,
10 mm hollow handle,
double-ended
10.5 mm | 4.5 mm,



DE-1570
Raspator, Prichard
Length 180 mm,
10 mm hollow handle,
double ended



DE-1571
Raspator, Prichard
Length 180 mm,
10 mm hollow handle,
double-ended
10.5 mm | 4.5 mm,



DE-1572
Mixing Spatula
with shovel
17cm



DE-1573
Mixing Spatula
with shovel
18.5cm

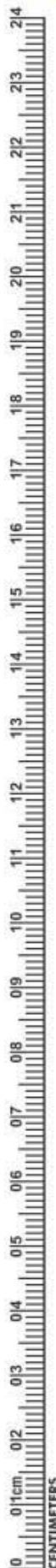

- Инструменты для имплантологии
- Implantologie
- Implantologie
- Инструменти для імплантології
- Implantologia
- زراعة الأسنان

BONE GRAFTING INSTRUMENTS COMPACTOR /TAMPERS

Product offering includes instruments for harvesting, mixing and compacting bone Provides clinicians with the proper instrumentation for bone grafting procedures Weighted bone basin Prevents tipping and spilling of bone and other materials during mixing



DE-1574
Graft Packer,
Concave Tips
DE 4/6mm

DE-1575
Bone Spoon/
Packer DE 3mm

DE-1576
Graft Packer,
Serrated Tips
DE 6/8mm

DE-1577
Graft Packer,
Serrated Tips
DE 3/4mm

DE-1578
Graft Packer,
Smooth Tips
DE 5/8mm

DE-1579
Titanium graft packer/
placement site depth
gauge 3.3mm & 4.0mm
Diameter tips Marked
at 8, 11, 13, 15 & 18mm

DE-1580
Graft Material Spoon
Concave Tip For
Larger Grafts

- Инструменты для имплантологии
- Implantologie
- Implantologie

- Інструменти для імплантології
- Implantologia
- زراعة الأسنان

BONE GRAFTING INSTRUMENTS

DE-1581
Blade and pusher
 Length 180 mm,
 for straight or angled,
 blade: 15 x 5 mm,
 pusher: 4 mm diameter
 Straight

DE-1582
Blade and pusher
 Length 180 mm,
 for straight or angled,
 blade: 15 x 5 mm,
 pusher: 4 mm diameter
 angular

DE-1583
Spoon and pusher
 Length 180 mm,
 for angled spoon:
 10 x 5 mm, pusher:
 diameter 3 mm

DE-1584
Tunnelierungs
Instrument
 length 175 mm,

DE-1585
Tunnelierungs
Instrument
 length 175 mm,
 different designs

DE-1586
Tamper
 Length 170 mm,
 for bone material,
 double-ended,
 diameter 3.2 mm
 (2-4-6-8-10) and diameter
 2.5mm (2-4-6-8-10)

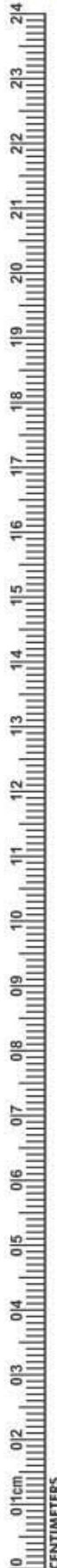

- Инструменты для имплантологии
- Implantologie
- Implantologie
- Інструменти для імплантології
- Implantologia
- زراعة الأسنان

Pluggers Clarizio

Length 160 mm, with titanium tips for mixing and pouring of autologous, heterologous bone substitute material, diameter (3/4 or 6/8 mm)

BONE GRAFTING INSTRUMENTS



DE-1587 Ø 4mm
DE-1588 Ø 5mm
Compactor
150mm



DE-1589
Sinus Window
Bone Tampers
4 mm



DE-1590
Sinus Window
Bone Tampers
7 mm



DE-1591
6/8mm



DE-1592
3/4mm



- Инструменты для имплантологии
 - Implantologie
 - Implantologie
- Інструменти для імплантології
 - Implantologia
 - زراعة الأسنان

SPOON AND PUSHER (TRINOVO)

Trinovo handle, different workers, for bone material, high-grade medical stainless steel, corrosion-resistant

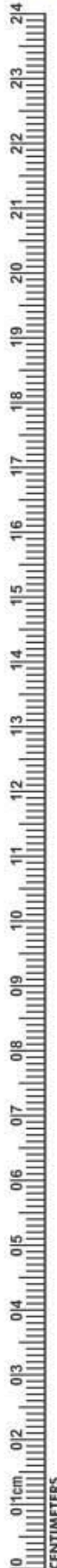

DE-1593
10x5mm

Spoon and Pusher
with safety stop

DE-1594
10x5mm

Spoon and Pusher
with safety stop

DE-1595
10x5mm

Spoon and Pusher
with safety stop

DE-1596
Bone Graft/Carrier
Titanium
2-4-6-8-10mm

DE-1597
15x10mm

Spoon and Pusher
with safety stop

DE-1598
10x5mm

Spoon and Pusher
with safety stop

DE-1599
10x5mm

Spoon and Pusher
with safety stop

- Инструменты для имплантологии
- Implantologie
- Implantologie
- Инструменти для імплантології
- Implantoloia
- زراعة الأسنان

PERIOSTEALS ELEVATOR 10mm Hollow Handle



DE-1600
Raspator,
BonexScraper
Length 165 mm,
10 mm hollow
handle,
double-ended 6
mm / 4 mm,

DE-1601
Raspator,
Raspatory
Length 180 mm,
10 mm hollow
handle,
double-ended
3 mm | 3 mm,

DE-1602
Raspator,
Raspatory
Length 180 mm,
10 mm hollow
handle,
double-ended
3 mm | 3 mm,

DE-1603
Raspator,
Papilla
Length 185 mm,
10 mm hollow
handle,
double-ended
3 mm | 2 mm,

DE-1604
Raspator,
bone scraper
Length 175 mm,
10 mm hollow
handle,
double-ended,

DE-1605
Raspator,
micro-Freer
Length 180 mm,
6 mm solid grip,
double-ended
3 mm | 4 mm

DE-1606
Raspator,
Freer
Length 180 mm,
6 mm solid
handle,
double-ended
5 mm | 5 mm,

- Инструменты для имплантологии
- Implantologie
- Implantologie

- Інструменти для імплантології
- Implantoloia
- زراعة الأسنان

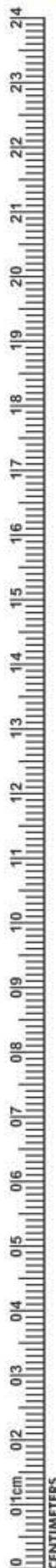
PERIOSTEALS ELEVATOR 10mm Hollow Handle

DE-1607
Raspator,
Freer
10 mm hollow
handle,
high-quality
medical
double ended



DE-1608
Raspator,
Molt
Length 180 mm,
8 mm solid
grip,
double-ended
6 mm



DE-1609
Raspator,
micro Freer
Length 185 mm,
10 mm hollow
handle,
double-ended,



DE-1610
Raspator,
micro Freer
Length 185 mm,
10 mm hollow
handle,
double-ended,



DE-1611
Raspator, micro
Raspator /
chisel
Length 170 mm,
10 mm hollow
handle,
double-ended,



DE-1612
Raspator, micro
Raspator /
chisel
Length 175 mm,
10 mm hollow
handle,
double-ended,



DE-1613
Raspator,
Micro Raspator /
chisel
Length 175 mm,
8 mm solid handle,
double-ended
3.5mm | 3.5 mm,

- Инструменты для имплантологии
- Implantologie
- Implantologie
- Инструменти для імплантології
- Implantoloia
- زراعة الأسنان

PERIOSTEALS ELEVATOR 10mm Hollow Handle



DE-1614
Raspatory Micro Molt
Length 175 mm,
corrosion-resistant

DE-1615
Raspatory Chipping
Workers:
Chisel 24G and 7.5 mm,
length about 175 mm,
corrosion-resistant

DE-1616
Raspatory MOLT
Work ends:
5.0 mm and 4.0 mm,
length about 175 mm,
corrosion-resistant

DE-1617
Rasp, Molt M9
Length 175 mm,
corrosion-resistant

DE-1618
Raspator, WAUTIER
Length 175 mm,
corrosion-resistant

DE-1619
Raspator, BENQUE
Length 170 mm,
workers
5 mm | 7 mm,
corrosion-resistant

DE-1620
Raspator, Nordberg
Length 180 mm,
8 mm hollow handle,
double-ended
6 mm | 4 mm

- Инструменты для имплантологии
- Implantologie
- Implantologie

- Інструменти для імплантології
- Implantologia
- زراعة الأسنان

Hollow Handle 10mm Length 170mm



DE-1621 Miller



DE-1622 Miller



DE-1623 LUCAS #84



DE-1624 LUCAS #85



DE-1625 LUCAS #86



DE-1626 LUCAS #87



DE-1627 LUCAS #88



DE-1628 LUCAS86S
SERRATED



DE-1629 LUCAS86AS
SERRATED

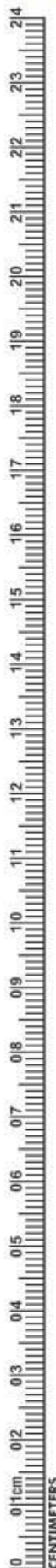

- Инструменты для имплантологии
- Implantologie
- Implantologie
- Инструменти для імплантології
- Implantoloia
- زراعة الأسنان

TISSUE MEMBRANE FORCEPS



DE-1630
Tissue Graft Forcep
Serrated Teeth



DE-1631
Self Locking
Grooved



DE-1632
Tissue Graft Forcep
Serrated Teeth



DE-1633
Titanium
Locking Plier



DE-1634
TC Gripper Carbide
Tipped Tissue Forceps
Serrated Carbide Tips
14.5cm



DE-1635
Adson Carbide
Tipped Tissue Forceps
Serrated Carbide Tips
12cm



DE-1636
Micor Adson 1x2
Tissue Forcep 12.1cm
1x2 Teeth - 0.5mm Tips



DE-1637
Adson 7x7
Tissue Forceps
7x7 Teeth 12cm



DE-1638
Adson 7x7 Curved
Tissue Forceps
7x7 Teeth 12cm



DE-1639
Suture Pliers
Suture Forceps with
1.6mm Ring Tip



DE-1640
Debakey Atraumatic
Tissue Forceps Straight
Serrated Teeth
16cm



DE-1641
Debakey Atraumatic
Tissue Forceps Curved
Serrated Teeth
16cm



- Инструменты для имплантологии
- Implantologie
- Implantologie

- Інструменти для імплантології
- Implantologia
- زراعة الأسنان

TISSUE MEMBRANE FORCEPS

DE-1642
Russian Long
Tissue Forceps
Serrated Tip
20cm



DE-1643
Russian
Tissue Forceps
Serrated Tip
15cm



DE-1644
Tissue Punch Forceps
To Remove Tissue
After Using Punch



DE-1645
13.5 cm
narrow
Membrane tweezers KUEHNE



DE-1646
10.5 cm
Membrane tweezers KUEHNE



DE-1647
13.5 cm
wide
Membrane tweezers KUEHNE



DE-1648
Pin-Tweezers
with or without lock,
length 15 cm,
with lock



DE-1649
without lock,
Haltepinzette with lock
15,5 cm, for pins, towards
the tips, etc.,



DE-1650
Haltepinzette with lock
15,5 cm, for pins, towards
the tips, etc.,



DE-1651
Carry Forceps
15cm



DE-1652
Carry Forceps
15cm



DE-1653
Carry Forceps
15cm

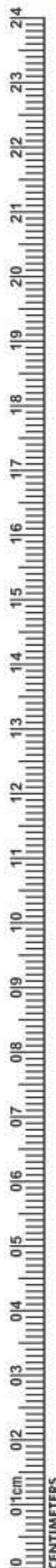

- Инструменты для имплантологии
- Implantologie
- Implantologie
- Инструменти для імплантології
- Implantoloia
- زراعة الأسنان

OSTEOTOME CONVEXES / CONCAVE / CONIQUES

CONVEXES



DE-1654
SET OF 5 PIECES

CONCAVES



DE-1655
SET OF 5 PIECES

CONIQUES



DE-1656
SET OF 5 PIECES

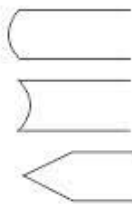
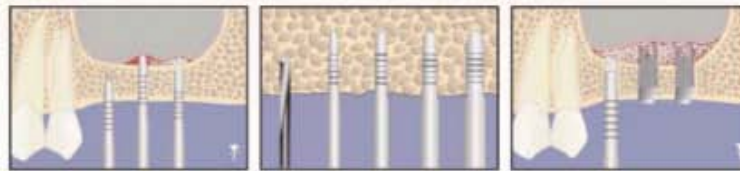

CONVEXES STRAIGHT	DE-1654	2,7 Ømm	3,2 Ømm	3,7 Ømm	4,2 Ømm	5 Ømm
CONCAVES STRAIGHT	DE-1655	2,7 Ømm	3,2 Ømm	3,7 Ømm	4,2 Ømm	5 Ømm
CONIQUES STRAIGHT	DE-1656	2,7 Ømm	3,2 Ømm	3,7 Ømm	4,2 Ømm	5 Ømm



- Инструменты для имплантологии
- Implantologie
- Implants
- زراعة الأسنان

OSTEOTOME CONVEXES / CONCAVE / CONIQUES

CONVEXES



DE-1657
SET OF 5 PIECES

CONCAVES



DE-1658
SET OF 5 PIECES

CONIQUES



DE-1659
SET OF 5 PIECES

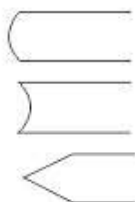
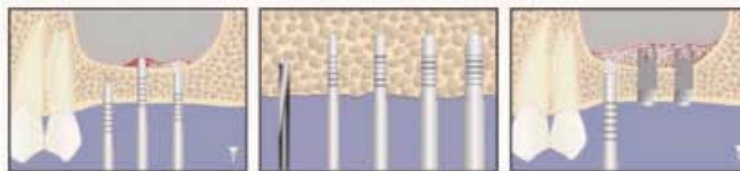

CONVEXES CURVED	DE-1657	2,7 Ømm	3,2 Ømm	3,7 Ømm	4,2 Ømm	5 Ømm
CONCAVES CURVED	DE-1658	2,7 Ømm	3,2 Ømm	3,7 Ømm	4,2 Ømm	5 Ømm
CONIQUES CURVED	DE-1659	2,7 Ømm	3,2 Ømm	3,7 Ømm	4,2 Ømm	5 Ømm

- Инструменты для имплантологии
- Implantologie
- Implantologie

- Инструменти для імплантології
- Implantologia
- زراعة الأسنان

TREPINE

Burs with depth markings are suited for precise and simple transplantation of cylindrical bone grafts as well as for all other bone-extraction tasks.



DE-1669
Tissue Punch with pin
Set of Four Pieces



DE-1670
Tissue Punch
Set of Five Pieces



DE-1671
Tissue Punch
Set of Five Pieces



DE-1672
Trephine Drill
Set of Eight Pieces



DE-1675
Trephine Drill
Set of Eight Pieces



- Инструменты для имплантологии
- Implantologie
- Implantologie

- Инструменти для имплантології
- Implantologia
- زراعة الأسنان

BONE SCRAPER STRAIGHT & CURVED



DE-1676
Bone Scraper
Straight

DE-1677
Bone Scraper
Curved

DE-1678
Tissue Punch
Straight

DE-1685
Tissue Punch
Curved

TISSUE PUNCH STRAIGHT & CURVED



DE-1679
2.0mm

DE-1680
4.0mm

DE-1681
5.0mm

DE-1682
6.0mm

DE-1683
7.0mm

DE-1684
8.0mm

DE-1686
2.0mm

DE-1687
4.0mm

DE-1688
5.0mm

DE-1689
6.0mm

DE-1690
7.0mm

DE-1691
8.0mm



DE-1692
Bone Mill



DE-1693
Basins For Bone



BONE CRUSHER
DE-1694

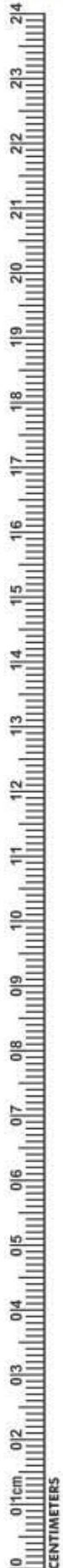

- Инструменты для имплантологии
- Implantologie
- Implantologie
- Инструменти для імплантології
- Implantologia
- زراعة الأسنان

KEYS FOR IMPLANT SCREW



DE-1695



DE-1696



DE-1697



DE-1698

TORQUE WRENCH & RATCHET



DE-1699 Star Torque Wrench 6.35mm Universal



DE-1700 Round Torque Wrench 4.0mm Universal



DE-1701 Hex Driver With 4.0mm Driver



DE-1702 Star Torque Wrench 6.35mm Universal



DE-1703 Hex Torque Wrench 4.00mm Universal



DE-1704 Star Torque Wrench 6.35mm Universal



DE-1705 Star Torque Wrench 6.35mm Universal



DE-1706 Star Torque Wrench 6.35mm Universal



DE-1707 Star Torque Wrench 6.35mm Universal



DE-1708 Star Torque Wrench 6.35mm Universal



DE-1709 Star Ratchet Wrench 6.35mm Universal



DE-1710 Star Ratchet Wrench 6.35mm Universal



DE-1711 Star Ratchet Wrench 6.35mm Universal



DE-1712 Star Ratchet Wrench 4.0mm Universal



DE-1713 Round Ratchet Wrench 4.0mm Universal



DE-1714 Round Ratchet Wrench 3.35mm Universal



DE-1715 Star Ratchet Wrench 4.0mm Universal



DE-1716 Star Ratchet Wrench 6.35mm Universal



- Инструменты для имплантологии
- Implantologie
- Implantologie

- Інструменти для імплантології
- Implantoloia
- زراعة الأسنان

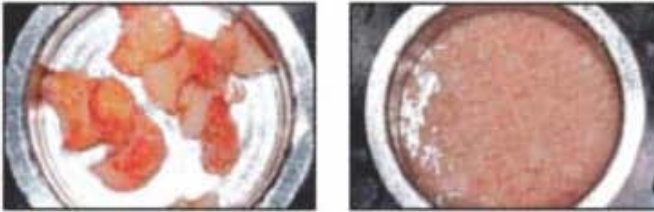

DE-1717
BONE CRUSHER
Titanium Metal Cutter

mallet



DE-1718
BONE CRUSHER
Titanium Metal Cutter

mallet

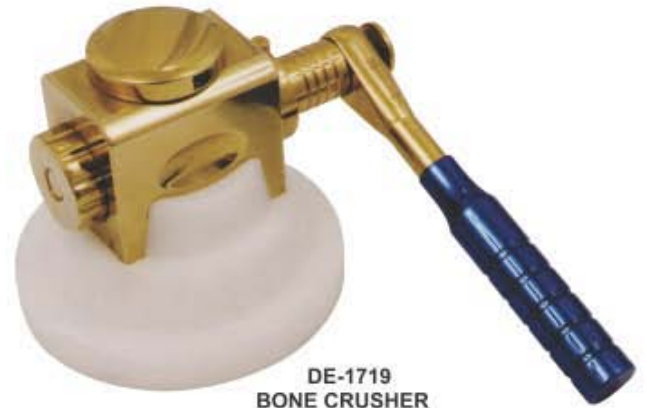

DE-1719
BONE CRUSHER



DE-1720
BONE CRUSHER
Bone Grinding Grain
1.5mm, 2mm, 2.5mm



DE-1721
BONE CRUSHER
Bone Grinding Grain
1.5mm, 2mm, 2.5mm

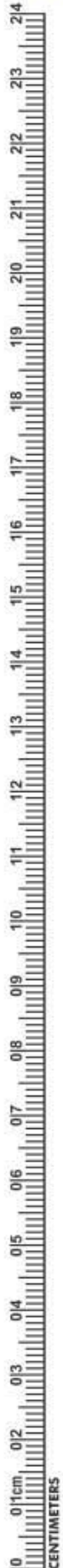

- Инструменты для имплантологии
 - Implantologie
 - Implantologie
- Инструменти для імплантології
 - Implantoloia
 - زراعة الأسنان

BONE EXPANDER SCREW & SURGICAL KITS



DE-1722
 Bone Universal Kit
 Drill: 2mm, 2.8mm, 3.2mm, 3.65mm,
 4.2mm, 4.5mm, 4.8mm, 5.2mm
 Trephines Bit:
 3.0mm, 4.0mm, 5.0mm, 6.0mm,
 7.0mm, 8.0mm, 9.0mm, 10mm.
 Driver:
 2.5mm, 2.5mm Hand Pcs
 1.25mm, 1.25mm Hand Pcs
 Short Driver 2.5mm
 Long Driver 2.5mm
 1.25mm, Short Hex Driver Hand Pcs
 1.25mm, Long Hex Driver Hand Pcs
 Torque Wrench 4.0mm



DE-1723
 Bone Expander Kit
 Expander: 2.6mm, 3.0mm,
 3.4mm, 3.8mm, 4.3mm
 Ratchet Driver
 Parallel Pin
 Pilot Drill
 Drill 1.4mm
 Drill Driver 4mm
 Hand Driver 4mm
 Ratchet 4.0mm



DE-1724
 Bone Universal Kit
 Drill: 2mm, 2.8mm, 3.2mm, 3.65mm,
 4.2mm, 4.5mm, 4.8mm, 5.2mm
 Trephines Bit:
 3.0mm, 4.0mm, 5.0mm, 6.0mm,
 7.0mm, 8.0mm, 9.0mm, 10mm.

Bone Compression:
 2mm, 3.3mm, 2.8mm, 4.2mm, 3mm, 3.5mm
 Driver:
 2.5mm, 2.5mm Hand Pcs
 1.25mm, 1.25mm Hand Pcs
 Short Driver 2.5mm
 Long Driver 2.5mm
 1.25mm, Short Hex Driver Hand Pcs
 1.25mm, Long Hex Driver Hand Pcs
 Torque Wrench 6.35mm 1 Pcs



DE-1725
 Conical Drills: 20 Pcs
 Tissue Punches:
 3.0mm, 3.50mm, 4.0mm, 4.5mm,
 5.0mm, 6.0mm, 6.50mm
 Bone Expander:
 1.6/3.8mm, 1.9/3.0mm, 2.1/3.6mm,
 2.6/3.8mm, 2.9/4.3mm
 Drill Adapter: 1 Pcs
 1.25mm, 2.50mm Hex Driver Hand Pcs

Pilot Drill: 1.6mm
 Drill Bit: 1.4mm, 1.6mm, 1.8mm, 2.0mm, 2.2mm
 Ratchet Driver: 4mm/6.35, 1.25/2.50
 Rimer: 3.2/4.7mm, 3.7/4.7mm
 Parallel Pin: 4.5mm, 2.5mm
 Double step Drill: 2.4/2.8mm
 Depth Gauge: 1 Pcs
 Torque Wrench 6.35mm Universal: 1 Pcs



- Инструменты для имплантологии
- Implantologie
- Implantologie

- Инструменти для имплантології
- Implantologia
- زراعة الأسنان

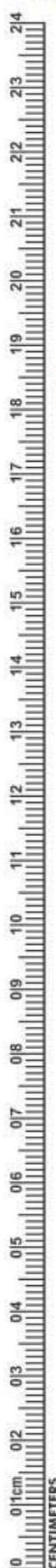
BONE INJECTORS, COLLECTORS & SUCTION TUBE

DE-1726
Ø 2,5mm /
3,5mm
170mm

DE-1727
Ø 4,5mm /
5,5mm
170mm

DE-1728
Ø 3,5mm /
4,5mm
170mm

DE-1729
Ø 6,0mm /
7,0mm
170mm



DE-1730
18cm
Straight / Bend
I.D 2.5mm
O.D 3.5

DE-1731
18cm
Straight / Bend
I.D 3.5mm
O.D 4.5

DE-1732
18cm
Straight / Bend
I.D 4.5mm
O.D 5.5

DE-1733
18cm
Straight / Bend
I.D 6.0mm
O.D 7.0



DE-1734
17.5cm

DE-1735
18cm

DE-1736
coarse
Ø 5mm

Suction tubes
to collect
the extracted
bone material
180mm



DE-1737
fine
Ø 9mm



DE-1738
Suction
Tubes
180mm

DE-1739
Suction
Tubes
180mm

DE-1740
Suction
Tubes
180mm



DE-1741
Fig. 6FR
Frazier
15 cm - Ø 2 mm

DE-1742
Ø 3 mm
length 180mm
DE-1743
Ø 4 mm
length 180mm
DE-1744
Ø 5 mm
length 180mm

IMPRESSION TRAYS



- Оттисковые ложки
- Відбиткові ложки
- Porte-empreinte
- Cubetas para impresiones
- Abdrucklöffel
- صواني الاطباع

PERFORATED WITH RIM LOCK

Set of 06 Pcs

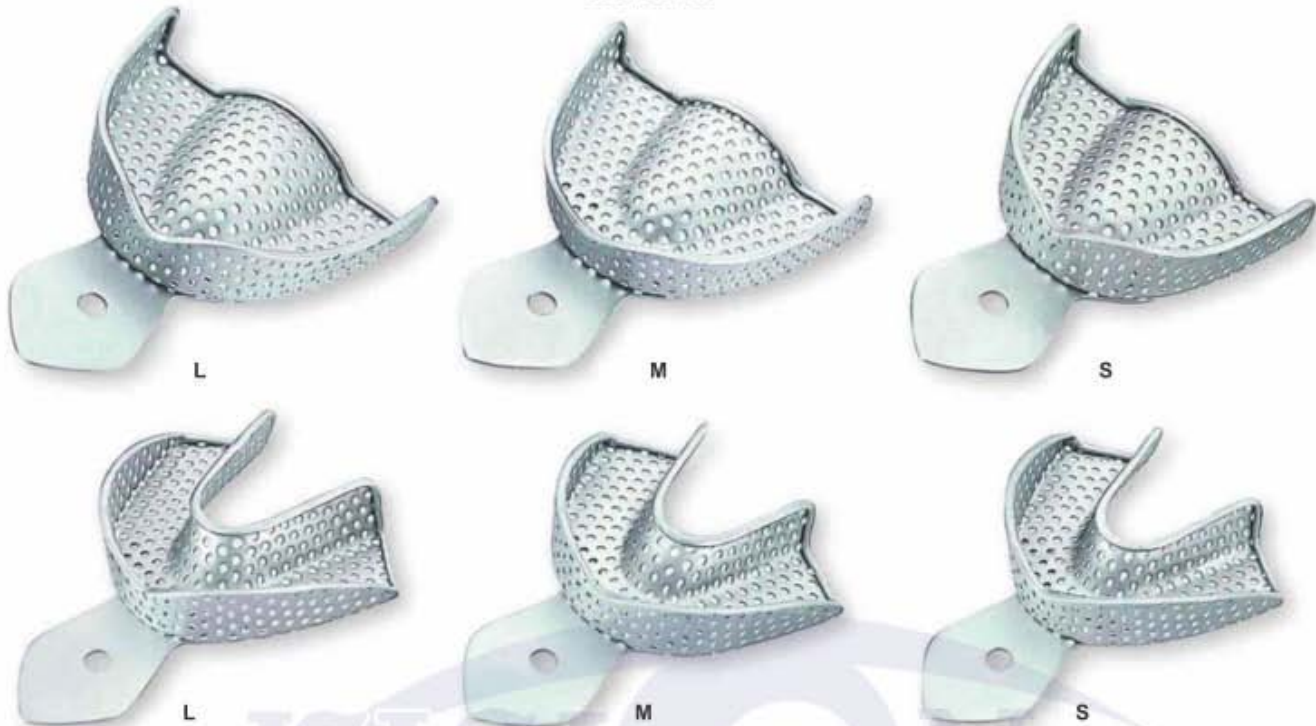

DE-1745 SET OF 06 PCS
Upper: S, M, L
Lower: S, M, L

PERFORATED WITH RIM LOCK

Set of 8 Pcs



DE-1746 SET OF 08 PCS
Upper: XS, S, M, L
Lower: XS, S, M, L

DE-1747 SET OF 08 PCS
Upper: S, M, L, XL
Lower: S, M, L, XL

DE-1748 SET OF 10 PCS
Upper: XS, S, M, L, XL
Lower: XS, S, M, L, XL



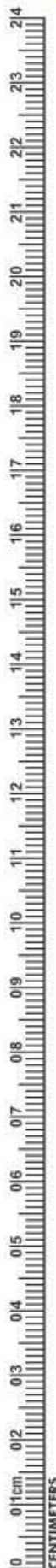

- Оттисные ложки
 - Porte-empreinte
 - Abdrucklöffel
- Відбиткові ложки
 - Cubetas para impresiones
 - صواني الإطباع

SOLID WITH RIM LOCK
Set of 6 Pcs



DE-1749 SET OF 06 PCS
Upper: S, M, L
Lower: S, M, L

SOLID WITH RIM LOCK
Set of 8 Pcs



DE-1750 SET OF 08 PCS
Upper: XS, S, M, L
Lower: XS, S, M, L

DE-1751 SET OF 08 PCS
Upper: S, M, L, XL
Lower: S, M, L, XL

DE-1752 SET OF 10 PCS
Upper: XS, S, M, L, XL
Lower: XS, S, M, L, XL

IMPRESSION TRAYS



- Оттисковые ложки
- Відбиткові ложки
- Porte-empreinte
- Cubetas para impresiones
- Abdrucklöffel
- صواني الاطباع

PERFORATED FULL DENTURE Set of 8 Pcs

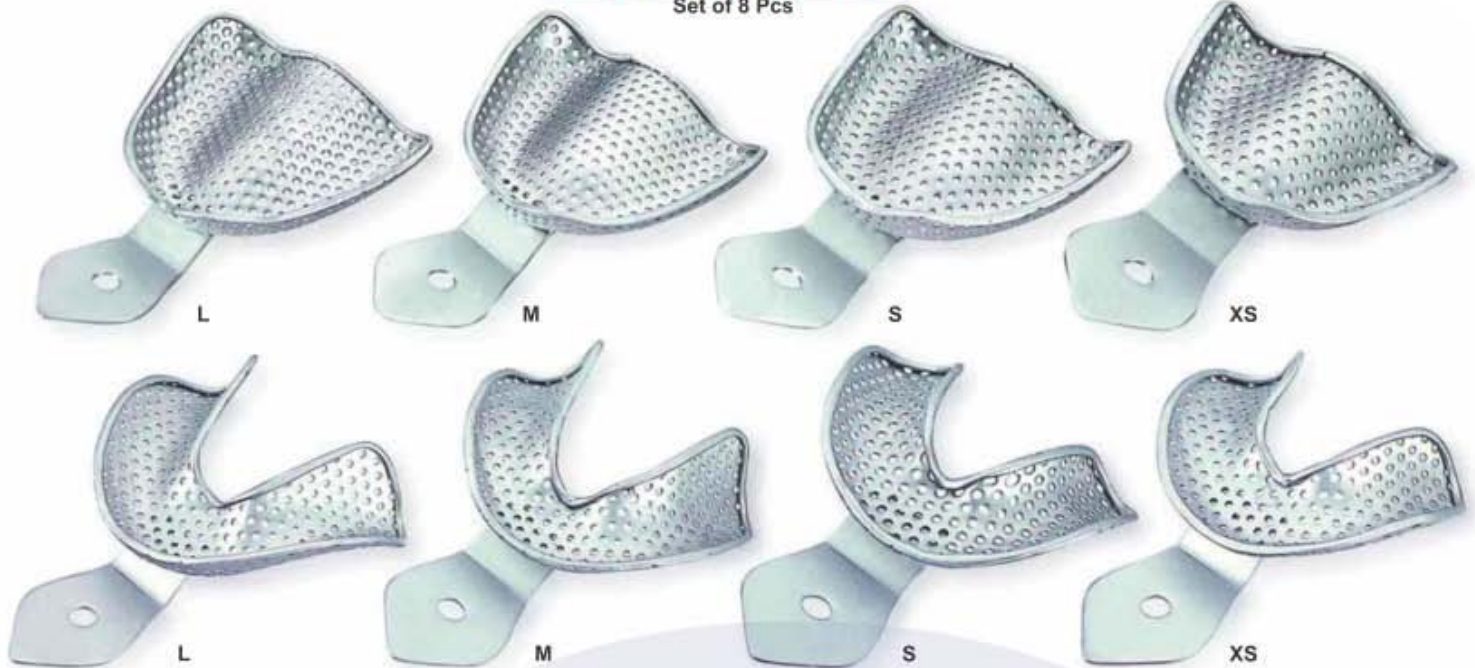

DE-1753 SET OF 08 PCS
Upper: S, M, L, XL
Lower: S, M, L, XL

DE-1754 SET OF 08 PCS
Upper: S, M, L
Lower: S, M, L

SOLID FULL DENTURE Set of 8 Pcs



DE-1755 SET OF 08 PCS
Upper: S, M, L, XL
Lower: S, M, L, XL

DE-1756 SET OF 06 PCS
Upper: S, M, L
Lower: S, M, L



- Оттисные ложки
 - Porte-empreinte
 - Abdrucklöffel
- Відбиткові ложки
 - Cubetas para impresiones
 - صواني الإطباع

Perforated Without Rim Lock



Solid With Rim Lock

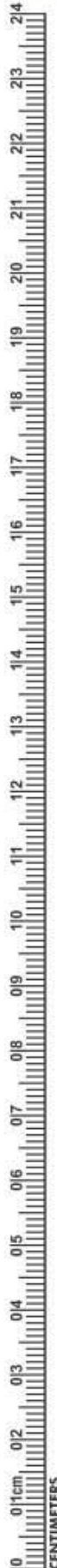
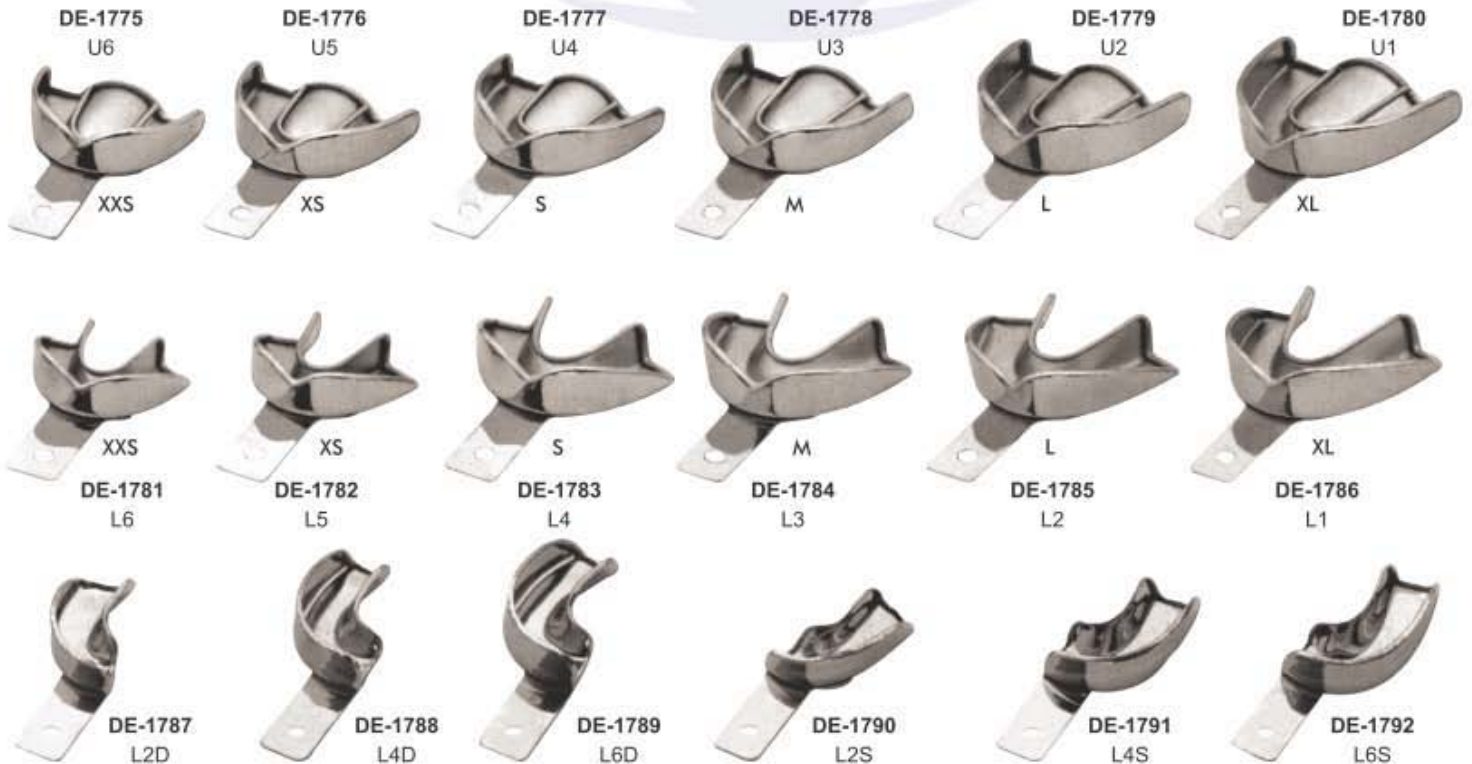



DE-1793
Instruments Cassettes
5 Pieces, 7 Pieces, 10 Pieces & 20 Pieces



DE-1794
Instruments Cassettes
5 Pieces, 7 Pieces, 10 Pieces & 20 Pieces

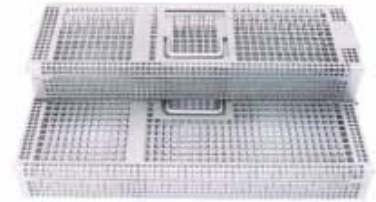

DE-1795
Instruments Cassette
7 Pieces & 10 Pieces



DE-1796
Gracey Curette Set Cassettes



DE-1797
182 x 150 x 20 mm
10 Instruments



DE-1798
180 x 85 x 15 mm
5 Instruments



DE-1799
288 x 182 x 35 mm
20 Instruments



DE-1800
288 x 182 x 35 mm
20 Instruments



DE-1801
182 x 145 x 35 mm
10 Instruments



DE-1802
182 x 72 x 35 mm
5 Instruments



DE-1803
182 x 145 x 35 mm
9 Instruments



DE-1804
Gracey Curette Set Stand



DE-1805
Sinus Lift Set Stand



Made of 18/8 stainless steel

KIDNEY TRAY WITH COVER
(English Pattern)

	Size
DE-1806	150 mm
DE-1807	200 mm
DE-1808	240 mm
DE-1809	300 mm

Kidney Trays

With lid available	Without lid available
DE-1810 6"	DE-1814 6"
DE-1811 8"	DE-1815 8"
DE-1812 10"	DE-1816 10"
DE-1813 12"	DE-1817 12"



Deep	
DE-1818	2.25" - 2"
DE-1819	4.75" - 2"
DE-1820	5.5" - 2.5"
DE-1821	6.25" - 2.75"
DE-1822	7" - 3.5"

Sterilizing Drum

Art #	Ø mm	h mm
DE-1823	80	80
DE-1824	120	120
DE-1825	160	120
DE-1826	190	140
DE-1827	190	200
DE-1828	240	120
DE-1829	240	160
DE-1830	240	240
DE-1831	290	120
DE-1832	290	160
DE-1833	290	240
DE-1834	340	160
DE-1835	340	240
DE-1836	390	145
DE-1837	390	200
DE-1838	390	290

Cotton Holder - DE-1839

Spirit Lamp DE-1840

DE-1841 Endodontic Box

Forcep Jar	
DE-1842	25 x 80mm
DE-1843	30 x 100mm
DE-1844	100 x 200mm
DE-1845	75 x 173mm

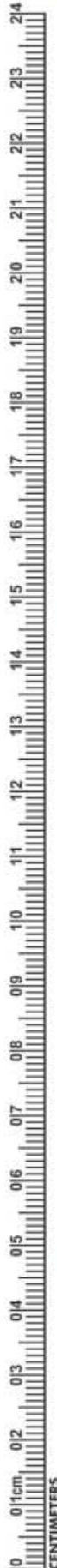

DE-1846 6" x 8"
DE-1847 8" x 10"
DE-1848 10" x 12"
 Without Lid

DE-1849 Instruments Box

SCALER TRAY DE-1850
 100 x 200 mm

DESCRIPTION	PAGE #	DESCRIPTION	PAGE #	DESCRIPTION	PAGE #
3 PRONG CLASP ADJUSTABLE PLIER TC	107	CARVERS FILLING INSTRUMENTS	69	FLAT NOSE PLIER WITH SERRATION	105
ACORN FILLING INSTRUMENTS	52	CARVERS INSTRUMENTS	73	FLOHR ROOT ELEVATORS	20
ADAM PLIER WITH TC	102	CARVERS	71	FLUCH-CUT DISTAL AND CUTTING PLIERS	100
ADAMS PLIER ROUND BOX	100	CASTROVIEJO NEEDLE HOLDERS	86	FOERSTER DRESSING FORCEPS	
ADAMS PLIERS FOR BENDING WIRE	100	CASTROVIEJO SCISSORS	84	FORCEP JAR	148
ADAMS, SMALL WIRE BENDING AND LOOP FORMING PLIERS	99	CEMENT SPATULAS	75	FREEDMAN "DUCKHEAD" IMPLANTOLOGY INSTRUMENTS	112
ADERER FACEBOW LOOP FORMING PLIERS	101	CHEEK RETRACTOR LONG	80	FREEDMAN BURNISHERS IMPLANTOLOGY INSTRUMENTS	112
ADERER LARGE WIRE BENDING AND LOOP FORMING PLIERS	100	CHEEK RETRACTOR	78	FREER PERIOSTEEL ELEVATORS	95
ADERER PLIER	101	CHEEK RETRACTORS, MINNESOTA	80	FRIEDMAN BONE ROUNGER	14
ADSON BROWN TWEEZERS	32	CHEEK RETRACTORS, RETRACTOR IVORY	80	FRIEDMANN ROOTS ELEVATOR	21
ADSON CARBIDE TIPPED TISSUE FORCEPS	133	CHEEK RETRACTORS, TONGUE DEPRESSORS	80	GAUGE FOR MEASURING	109
ADSON NEEDLE HOLDERS	86	CHISELS HOES FILLING INSTRUMENTS	74	GERALD TWEEZERS	31
ADSON TWEEZERS	32	CLAMP OSTEOMETER	109	GILLIES TWEEZERS	31
ADSON-TC TWEEZERS	32	CLAPPISON/FRAHAM RESTORATIVE INSTRUMENTS	70	GILLIES NEEDLE HOLDER WITH SCISSORS	
ALLEN PERIOSTEEL ELEVATORS	95	CLAW-LIFT ROOTS ELEVATOR	22	GOLDMAN FOX EXPLORERS	36
ALLIS 4:5 HAEMOSTATIC FORCEPS	87	COHEN UNIVERSAL FORCEPS	10-11	GOLDMAN FOX MERRIT B EXPLORERS	36
ALLIS-BABY 3:4 HAEMOSTATIC FORCEPS	87	COLLEGE CURVED	32	GOLDMAN FOX UNIVERSITY OF MICHIGAN EXPLORERS	36
AMALGAM CARVERS	56-57, 70-71	COLLEGE TWEEZER	32	GOLDMAN FOX WILLIAMS EXPLORERS	36
AMALGAM FILES	71	COLLEGE WITH LOCK TWEEZERS	31	GOLDMAN PERIODONTAL INSTRUMENTS	58
AMALGAM INSTRUMENTS & SCALPEL HANDLES	92	COLLINS TONGUE FORCEPS		GOLDMAN-FOX PERIOSTEEL ELEVATORS	95
AMALGAM INSTRUMENTS	93	COMPOSITE/PLASTIC FILLING INSTRUMENTS	49-50, 54	GOLDMAN-FOX SCISSORS	83-84
AMALGAM WELL MATRIX RETAINERS	91	CONDENSER INSTRUMENTS	118	GOLDMAN-FOX SET	61
AMALGAM WELL	93	CONDENSER MORTONSON FILLING INSTRUMENTS	50	GOLDSTEIN INTERPROXIMAL EXCAVATOR	67
ANATOMICAL CARVER	71	CONTOURING INSTRUMENT IMPLANTOLOGY INSTRUMENTS	111	GRACEY AFTER FIVE	42
ANDREW RESTORATIVE INSTRUMENTS	70	CONTOURING PLIER	101	GRACEY CURETTE INSTRUMENTS	62
ANGLE FORMERS	72	COSMETIC CONTOURING	113	GRACEY CURETTE SET CASSETTES	147
ANGLED DIRECT BOND BRACKET REMOVER TC	106	COTTON HOLDER	148	GRACEY CURETTE	43
ANISWORTH CLAMPS FORCEPS	88	COUPLAND ROOT ELEVATORS	17	GRACEY MINI FIVE	42
ANTERIOR FILLING INSTRUMENTS	68	COUPLAND ROOT ELEVATORS	18	GRACEY PERIODONTAL INSTRUMENTS	39
ANTERIOR	47	CRANE KAPLAN TWEEZERS	32	GRACEY SET OF 7 PCS	40-41
APEXO ROOT ELEVATORS	15-19	CRANE-KAPLAN PERIODONTAL INSTRUMENTS	59	GRAFT PACKER, CONCAVE TIPS	125
APICAL ROOT ELEVATORS	19	CRILE NEEDLE HOLDERS	85	GREGG IMPLANTOLOGY INSTRUMENTS	111
ARCH FORMING PLIERS	104	CRILE-WOOD NEEDLE HOLDERS	85-86	GRITMAN CEMENT SPATULAS	75
ARTICULATORS	77	CROWN AND BAND CONTOURING PLIERS	105	GROSS MAIER DRESSING FORCEPS	
A-TRAUMATIC EXTRACTION SET	03	CROWN REMOVER	90	GUM SCISSORS	
ATRAUMATIC TWEEZERS	31	CROWN SPREADERS	90	HAEMOSTATIC FORCEPS & TOWEL CLAMPS	87
BACK ACTION FILLING INSTRUMENTS	52	CRYSER EXTRACTING FORCEPS	10	HALSEY NEEDLE HOLDERS	85-86
BACKHAUS HAEMOSTATIC FORCEPS	87	CRYSER ROOTS ELEVATOR	23	HALSTEAD MOSQUITO HAEMOSTATIC FORCEPS	87
BACOLITE HANDLE WAX KNIVES	76	CURETTE COLUMBIA	43	HALSTEAD MOSQUITO NEEDLE HOLDERS	86
BALDWIN FILLING INSTRUMENTS	49	CURETTE INSTRUMENTS	63	HALTEPINZETTE WITH LOCK	134
BALL FILLING INSTRUMENTS	52	CURETTE MCCALL	43	HAMMER HEAD TIE BACK PLIER	104
BALL HOOK CRIMPING PLIER	105	CURETTE	60	HANDLES FOR MOUTH MIRRORS	30
BAND PUSHER	90	CURETTERS SET OF 8 PIECES	43	HARD WIRE CUTTERS	107
BAND REMOVING PLIER	99	CURETTERS	40-43, 61-62	HARRIS EXTRACTING FORCEPS	11
BAND SEATER AUTO CLEAVABLE	97	CUTTING INS PERIODONTAL INSTRUMENTS	39	HARTMANN (BABY MOSQUITO) NEEDLE HOLDERS	86
BAND SEATING PLIER	104	DARBY-PERRY EXCAVATORS	65	HATCHETS FILLING INSTRUMENTS	68
BANDS & CROWNS PLIER	101	DE LA ROSA PLIERS WITH GROOVED	105	HEAT CARRIERS	68
BASINS FOR BONE	138	DE LA ROSA PLIERS	105	HEBER ROOTS ELEVATOR	24
BAUMGARTER NEEDLE HOLDERS	85	DEAN SCISSORS	84	HEIDBRINK ROOT ELEVATORS	20-21, 24
BAUMGARTNER NEEDLE HOLDERS	86	DEBAKEY ATRAUMATIC TISSUE FORCEPS	133	HEIDMANN PERIODONTAL INSTRUMENTS	39
BAYONET ROOTS ELEVATOR SET	21	DEEP BOWL	148	HEMINGWAY CURETTE INSTRUMENTS	63
BEAVERTAIL FILLING INSTRUMENTS	52	DEEP ROOT PICK FORCEPS (APICAL SET OF 9)	04	HEMINGWAY TWEEZERS	32
BEEBEE NEEDLE HOLDERS	85	DELICATE NEEDLE HOLDERS	85	HOES	71
BEIN ROOT ELEVATORS	15-16, 24	DELUXE BRACKET HOLDER TWEEZERS	96	HOLLANBACK PERIODONTAL INSTRUMENTS	39
BEYER BONE ROUNGER	14	DENHARD CHEEK RETRACTORS	79	HOLLANBACK FILLING INSTRUMENTS	50
BINANGLE FILLING INSTRUMENTS	74	DENTAL MIRROR PERIODONTAL INSTRUMENTS	39	HOLLANBACK IMPLANTOLOGY INSTRUMENTS	114
BIRD BEAK ANGLED BENDING PLIER	103	DENTAL SYRINGES	13	HOLLANBACK RESTORATIVE INSTRUMENTS	70
BIRD BEAK PLIER WITH TC	102	DERF NEEDLE HOLDERS	85	HOLLOW HANDLE	132
BIRD BEAK WIRE BENDING & CUTTING PLIERS	101	DERF NEEDLE HOLDERS	86	HOLLOW WARE	148
BIRD BEAK WIRE BENDING PLIER	100	DIRECT BOND BRACKET HOLDER TWEEZERS	96	HOLLOWCHOP CONTOURING PLIERS	106
BIRD BEAK WITH CUTTER PLIERS	104	DIRECT BONDING BRACKET HOLDERS	96	HOOK CRIMPING PLIER ANGLED STRAIGHT TC	107
BLACK FILLING INSTRUMENTS	50	DIRECT BONDING BRACKET REMOVER PLIER TC	106	HOOK KNIVES	76
BLACK TITANIUM COLOUR COATED INSTRUMENTS	110-111	DIRECT BRACKET REMOVER TC	107	HOW PLIER CURVED WITH TC	103
BLADE AND PUSHER	126	DISCOID-CLEOID CARVER	71	HOW PLIER CURVED	99, 104
BLUMENTHAL BONE ROUNGER	14	DISTAL END CUTTER REGULAR WITH T.C	102	HOW PLIER STRAIGHT WITH TC	103
BOGHOSIAN FILLING INSTRUMENTS	49	DISTAL END CUTTER, SAFETY HOLD PLIER		HOW PLIER STRAIGHT	103
BOGHOSIAN IMPLANTOLOGY INSTRUMENTS	111	(IDEAL FOR CUTTING WIRE) TC	107	HOWARD PERIOSTEEL ELEVATORS	95
BOLEY GAUGE	109	DISTAL END, WIRE CUTTERS & BRACKET REMOVER PLIERS	107	HYGIENIST PERIODONTAL INSTRUMENTS	58
BONE BRACKET GAUGE	96	DOUBLE ENDED CEMENT SPATULA	96	HYGIENIST-JACQUETTE PERIODONTAL INSTRUMENTS	58
BONE CARRIER TITANIUM	124	DRESSING TWEEZERS	31-32	HYGIENIST-TOWNER PERIODONTAL INSTRUMENTS	58
BONE CRUSHER	138, 140	ELASTIC SEPARATING PLIER	107	HYLIN CEMENT SPATULAS	75
BONE EXPANDER SCREW & SURGICAL KITS	141	ELASTOMERIC LIGATURE PLACING FORCEPS		HYLIN ROOTS ELEVATOR	23
BONE FILES	94	WITH GROOVE FALCON	107	IMPLANT GAGES	108
BONE GRAFT/CARRIER TITANIUM	128	ELLIOT MATRIX RETAINERS	91	IMPLANT SINUS LIFT INSTRUMENTS	117, 122
BONE GRAFTING INSTRUMENTS COMPACTOR /TAMPERS	125	ENDED CHEEK RETRACTORS	79	IMPLANT	123
BONE GRAFTING INSTRUMENTS	126-127	ENDODONTIC BOX	148	IMPLANTOLOGY IMPLANTOLOGY INSTRUMENTS	111
BONE INJECTORS, COLLECTORS & SUCTION TUBE	142	ENDODONTICS INSTRUMENTS	47	IMPLANTOLOGY INSTRUMENTS	112
BONE MILL	138	ENGLISH PATTERN KLEIN #3 PEDODONTIC UNIVERSAL FORCEPS	08	IMPLANTOLOGY	108-110
BONE ROUNGER	14	EXAMINATION KIT SET OF 3 PIECES	34	IMPRESSION TRAYS	143-146
BONE SCRAPER STRAIGHT & CURVED	138	EXAMINATION SET OF 4 PIECES	34	INSTRUMENTS BOX	148
BONE SPOON/ PACKER	125	EXAVATORS	37	INSTRUMENTS CASSETTES & STANDS	147
BONE THICKNESS GAUGE	109	EXCAVATOR PERIODONTAL INSTRUMENTS	39	INTERPROXIMAL CARVER IMPLANTOLOGY INSTRUMENTS	111
BONE UNIVERSAL KIT	141	EXCAVATORS INSTRUMENTS SET OF 11 PIECES	57	INTERPROXIMAL OFF-ANGLE FILLING INSTRUMENTS	49
BRACKET REMOVER ANGULATED PLIER	103	EXCAVATORS INSTRUMENTS	64-67	INTRALIGAMENTAL ANESTHESIA SYRINGE	13
BRACKET REMOVER PLIER STRAIGHT	103	EXCAVATORS	64	IRIS SCISSORS	83-84
BRACKET REMOVER PLIERS ANGLED WITH T.C	102	EXPLORER PERIODONTAL INSTRUMENTS	39	IVORY LIGHT WEIGHT CLAMPS FORCEPS	88
BRACKET REMOVER PLIERS STRAIGHT WITH T.C	102	EXPLORERS INSTRUMENTS	35	IVORY MATRIX RETAINERS	91
BRACKET REMOVING PLIER ROUND BOX	99	EXPLORERS	33-45	IWANSON SPRING CALIPER	109
BRACKET REMOVING PLIER	99	EXTRACTING FORCEPS (AMERICAN PATTERN)	10-14	JACQUETTE SCALERS PERIODONTAL INSTRUMENTS	59
BREWER CLAMPS FORCEPS	88	EXTRACTING FORCEPS (ENGLISH PATTERN)	01-02, 05-07	JARA BEAK PLIER	104
BURNISHER FILLING INSTRUMENTS	49	EXTRA-FLEX IMPLANTOLOGY INSTRUMENTS	114	JENNINGS CHEEK RETRACTORS	79
BURNISHER FILLING INSTRUMENTS	54	FALCON BEAK CONTOURING PLIERS	100	JOHNSON CONTOURING PLIERS	100
BURNISHER UNIVERSITY OF MICHIGAN AMALGAM CARVERS	56	FARABEUF RETRACTOR	82	JONES HAEMOSTATIC FORCEPS	87
BURNISHERS FILLING INSTRUMENTS	52-53	FELDMAN RETRACTOR	82	JOSEPH SCISSORS	84
BURNISHERS IMPLANTOLOGY INSTRUMENTS	112	FILES FILLING INSTRUMENTS	53	KELLY HAEMOSTATIC FORCEPS	87
BUSER PERIOSTEEL ELEVATORS	95	FILLING INS PERIODONTAL INSTRUMENTS	39	KELLY SCISSORS	83-84
CARRY FORCEPS	134	FILLING INSTRUMENTS	37, 44, 49-55, 69, 72	KELLY-RANKIN HAEMOSTATIC FORCEPS	87
CARVER HOLLANBACK AMALGAM CARVERS	56	FLAT NOSE PLIER SMOOTH	105	KEYS FOR IMPLANT SCREW	139

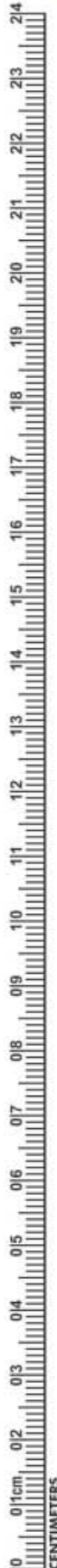



DESCRIPTION	PAGE #	DESCRIPTION	PAGE #	DESCRIPTION	PAGE #
KIDNEY TRAY WITH COVER (ENGLISH PATTERN)	148	ORTHO LIGHT SCALER HEAVY	97	SINUS LIFT INSTRUMENT	118-121
KIDNEY TRAYS	148	ORTHO LIGHT SCALER SINGLE ENDED	98	SINUS LIFT SET STAND	147
KILNER (RAGNELL) SCISSORS	84	ORTHO LIGHT SCALER	97	SINUS WINDOW BONE TAMPERS	127
KLEINERT-KUTZ BONE ROUNDING	14	ORTHODONTIC INSTRUMENTS	96-98	SINUSLIFT INSTRUMENTS	118
KOPP ROOTS ELEVATOR	23-24	ORTHOLITE LIGATURE DIRECTOR SCALER	98	SIOVELAND RETAINERS TOFFLEMIRE-JUNIER MATRIX RETAINERS	91
KRARNER-NEVINS BONE CHISEL	94	OSTEOMETER MEASURING FORCEPS	96	SMAHA ELASTOMERIC LIGATURE PLACING FORCEPS	107
LA GRANGE SCISSORS	83-84	OSTEOTOME CONVEXES / CONCAVE / CONIQUES	135-136	SPENCER SCISSORS	84
LADMORE FILLING INSTRUMENTS	52	OVAL SPOONS/DARBY-PERRY	65	SPIRIT LAMP	148
LADMORE IMPLANTOLOGY INSTRUMENTS	112	P.K. THOMAS WAXING INSTRUMENTS	73	SPOON AND PUSHER (TRINOVO)	128
LAP-JOINT THREE PRONG PLIER	106	PALATAL ARCH PLIER	105	SPOON AND PUSHER WITH SAFETY STOP	128
LAXUTOR ROOT ELEVATORS	19	PALMER CLAMPS FORCEPZ	88	SPOONS	64
LE CRON CEMENT SPATULAS	75	PDL ELEVATORS	28-29	SPREADERS	46
LESSMANN	76	PEDIATRIC TOOTH EXTRACTING FORCEPS SET	09	STANDARD LIGATURE CUTTER TC	106
LIGATURE FORMING PLIERS	101	PERIODONTAL FILLING INSTRUMENTS	53	STEP PLIERS WITH TC	103
LIGHT WIRE BIRD BEAK LONG PLIER WITH TC	102	PERIODONTAL INSTRUMENTS	37, 39, 58, 60, 95	STERILIZING DRUM	148
LIGHT WIRE BIRD BEAK LONG PLIER	104	PERIODONTAL PROBES	46, 48	STOP V BENDING PLIER	105
LIGHT WIRE BIRD BEAK PLIERS	104	PERIOSTEALS ELEVATOR	95, 129-130	STRAIGHT DIRECT BOND BRACKET REMOVER TC	107
LIGHT WIRE CUTTER MICRO WITH TC	102	PERIOTOME ROOTS ELEVATOR	26	SURGICAL CHISELS	123
LIGHT WIRE PLIER	104	PERRY TWEezer	31-32	SURGICAL TWEEZERS	31
LINDO LEVIAN ROOT ELEVATORS	20	PESTERIOR BEND REMOVER PLIER LONG	103	SUTURE PLIERS SUTURE FORCEPS	133
LINGUAL / PALATAL ARCH FORMING PLIERS	101	PESTERIOR BEND REMOVER PLIER MEDIUM	103	SYNDESMOTOMES ROOTS ELEVATOR	26
LINGUAL PLIER LONG HANDLE	106	PESTERIOR BEND REMOVER PLIER SHORT	103	TAMPER	126
LINGUAL PLIER WEINGART	106	PIN & LIGATURE CUTTERS TC	106	TANNER FILLING INSTRUMENTS	52, 69
LINGUAL WEINGART PLIER	106	PIN HOLDING PLIER TC	107	TANNER IMPLANTOLOGY INSTRUMENTS	114
LINING APPLICATOR DOUBLE END	55	PIN-TWEEZERS	134	TC GRIPPER CARBIDE	133
LOCKLIN SCISSORS	84	PLAIN MIRRORS	30	THARP RESTORATIVE INSTRUMENTS	70
LONDON COLLEGE TWEEZERS	31	PLASTER KNIFE 76 SPECIAL INOX	76	THREE PRONG PLIERS REGULAR	106
LORNA HAEMOSTATIC FORCEPS	87	PLIERS FOR ORTHODONTICS & PROSTHETICS	99-106	TISSUE GRAFT FORCEP SERRATED TEETH	133
LUCAS	132	PLUGGER PERIODONTAL INSTRUMENTS	39	TISSUE MEMBRANE FORCEPS	132, 134
LUER BONE ROUNDING	14	PLUGGER BLACK AMALGAM CARVERS	56	TISSUE PUNCH FORCEPS	134
LUKS	47	PLUGGERS	45, 48	TISSUE PUNCH STRAIGHT & CURVED	138
LUXATOR ROOT ELEVATORS	15-16, 21	PLUGGERS/CONDENSERS FILLING INSTRUMENTS	50	TOFFLEMIRE-SENIOR MATRIX RETAINERS	91
LUXIER ROOTS ELEVATOR	22	PLUGGERS/CONDENSERS	51	TOFFLEMIRE-UNIVERSAL MATRIX RETAINERS	91
MAGNIFYING MIRRORS	30	POINTED CURETTE	60	TORQUE WRENCH & RATCHET	139
MANUAL CROWN REMOVER	90	POINTED PROBES SINGLE ENDED	36	TOWNER PERIODONTAL INSTRUMENTS	58
MARCOTTE LOOPING PLIER	105	POSTERIOR	48	TOWNER-JACQUETTE PERIODONTAL INSTRUMENTS	58
MARGIN TRIMMERS	73	POSTERIOR BAND REMOVER PLIERS	102	TREPHINE DRILL SET OF EIGHT PIECES	137
MARGINAL RIDGE & EMBRASURE SHAPING INSTRUMENT	112	POTT ROOTS ELEVATOR	25	TUFTS FILLING INSTRUMENTS	49
MARKLEY PLUGGERS/CONDENSERS	51	POWER CROWN REMOVER LIFT	90	TUNNELIERUNGS INSTRUMENT	126
MARQUETTE FILLING INSTRUMENTS	50	PRICHARD PERIOSTEEL ELEVATORS	95	TWEEZ / ANGLE FORMING AND TORQUING PLIERS	101
MARYAM TWEEZERS	32	PROBES DOUBLE ENDED	35	TWEEZ / ANGLE RECTANGULAR ARCH FORMING & TORQUING PLIERS	100
MATHIEU NEEDLE HOLDERS	96	PROBES SINGLE ENDED	34	TWEEZ ARCH FORMING PLIER TC	102
MATRIX RETAINERS	91	QUETIN FILLING INSTRUMENTS	49	TWEEZ CUTTER PLIER	104
MAYO NEEDLE HOLDERS	85	RASPATOR, BENQUE	131	TWEEZ LOOP FORMIN PLIERS	100
MAYO SCISSORS	83	RASPATOR, FREER	129, 131	TWEEZ LOOP FORMING PLIER TC	105
MAYO-HEGAR NEEDLE HOLDERS	85-86	RASPATOR, MICRO FREER	131	TWEEZ LOOP FORMING PLIER	99
MEAD 1A BONE ROUNDING	14	RASPATOR, MICRO RASPATOR / CHISEL	131	TWEEZ LOOP PLIER	104-105
MEAD BONE FILES	94	RASPATOR, MICRO-FREER	129	TWEEZER PERIODONTAL INSTRUMENTS	31
MEASURING LOOP	109	RASPATOR, NORDBERG	131	TWEEZERS	32
MEASURING LOOP, CASTROVIEJO	109	RASPATOR, PRICHARD	124	TWEL-ON ELASTIC MODULE INSTRUMENT	97
MEDIUM CEMENT CEMENT SPATULAS	75	RASPATOR, RASPARTORY PERIOSTEEL ELEVATORS	95	UNIVERSAL DOLPHIN STYLE WIRE BENDING & CUTTING PLIERS	99
MEDIUM PLACING/CONDENSING IMPLANTOLOGY INSTRUMENTS	114	RASPATOR, WAUTIER	131	UNIVERSAL FILLING INSTRUMENTS	49
MEMBRANE POSITIONING INSTRUMENTS	118	RASPATOR, WILLIGER PERIOSTEEL ELEVATORS	95	UNIVERSAL FILLING INSTRUMENTS	54
MEMBRANE TWEEZERS KUEHNE	134	RASPATORY CHIPPING	131	UNIVERSAL NEEDLE HOLDERS	85
MERIAM TWEEZERS	31	RASPATORY MICRO MOLT	131	UNIVERSITY OF MICHIGAN EXPLORERS	36
MERRIT A EXPLORERS	36	RASPATORY MOLT	131	UTILITY PLIER WEINGART TC	107
MERRIT B EXPLORERS	36	REGULAR TWEEZ ARCH FORMING PLIERS	104	V BEND STOP PLIER TC	106
MERSON CROWN REMOVER	90	RESTORATIVE INSTRUMENTS	51-53, 68, 70-72	W. BARRY ROOTS ELEVATOR	25
METZENBAUM NEEDLE HOLDERS	85	RETRACTOR WITH ERGO GRIP	90	WAHL BONE FILES	94
METZENBAUM SCISSORS	83	RETRACTORS - MOUTH GAGS	78-79	WALDSAVHS WIRE BENDING AND CUTTING PLIERS	101
MICOR ADDSON TISSUE FORCEP	133	RETRACTORS	80-82	WALL FILLING INSTRUMENTS	69
MICRO IRIS SCISSORS	83	RETRACTORS CHEEK RETRACTOR COMBINATION COMBINATION	80	WANGEN HOLDER	78
MICRO-FRIEDMAN BONE ROUNDING	14	RETRACTORS COMBINATION	61	WARD AMALGAM CARVERS	56
MILLER BONE FILES	94	RETRACTORS, LANGENBECK	82	WARD FILLING INSTRUMENTS	69
MILLER TWEEZERS	32	RETRACTORS, MIN-LANGENBECK	81	WAX KNIVES	76
MILLER	132	RETRACTORS, UNIQUE	81	WEDELSTAEDT	71
MINI LIGATURE CUTTERS	100	RETRO FILLING	48	WEINGART GENERAL UTILITY PLIER LONG MOUTH WITH TC	103
MINI PIN & LIGATURE CUTTER TC	106	REVERSED LIGATURE CUTTER ANGLED	102	WEINGART PLIER MEDIUM	99-101
MIXING SPATULA WITH SHOVEL	124	RHOIDIUM MIRRORS	30	WEINGART PLIER REGULAR WITH TC	103
MODIED MCCALL	60	ROCHESTER-KOCHER 1X2 HAEMOSTATIC FORCEPS	87	WEINGART PLIER SLIM WITH TC	102
MOLT BONE FILES	94	ROCHESTER-PEAN HAEMOSTATIC FORCEPS	87	WEINGART PLIER UNIVERSAL WITH TC	103
MOLT PERIOSTEEL ELEVATORS	95	ROOT ELEVATOR	15-29	WEINGART PLIER UTILITY WITH TC	103
MORTONSEN FILLING INSTRUMENT	55	ROOT PLANNING FILES	94	WEITLANDER CHEEK RETRACTORS	79
MOUTH GAG MOLT	78	ROOT PLANNING FILES & BONE FILES	94	WEITLANER CHEEK RETRACTORS	79
MOUTH MIRROR	37	ROOTS ELEVATOR	22	WERDELSTAEDT FILLING INSTRUMENTS	74
MSY CEMENT SPATULAS	75	ROSER-KONIG CHEEK RETRACTORS	79	WESTON CEMENT SPATULAS	75
MULTIFUNCTIONAL METER	108	ROUND NOSE PLIER	104	WIDE MATRIX RETAINERS	91
NAKAWALL DENTAL LABORATORY INSTRUMENTS	77	ROUNDED CONE	73	WILLIAM PROBE SET	38
NANCE LOOP FORMING PLIERS	99	ROUNDED-CONE FILLING INSTRUMENTS	49	WILLIAMS EXPLORERS	36
NANCE PLIER	105	RUBBER DAM CLAMPS	89	WINGURT PLIER SLIM	105
NARROW MATRIX RETAINERS	91	RUBBER DAM CLAMPS FORCEPS	89	WINGURT UTILITY PLIER	105
NEEDLE HOLDERS	85-86	RUSSIAN LONG TISSUE FORCEPS	134	WINTER ROOTS ELEVATOR	25
NEUMANN SCISSORS	84	RUSSIAN TISSUE FORCEPS	134	WIRE BENDING & LOOP FORMING PLIERS	99
NOYES SCISSORS	84	SCALER TRAY	148	WISDOM ROOTS ELEVATOR	21
OCCUSAL ANATOMY INSTRUMENT	113	SCALERS/CURETTE SETS	60	WOODEN HANDLE	76
OHLE PERIOSTEEL ELEVATORS	95	SCALERS/CURETTE SETS INSTRUMENTS	61	WOODSON FILLING INSTRUMENTS	49
OLSEN-HEGAR NEEDLE HOLDER WITH SCISSORS	95	SCHURE BAND SEATER	57	YOUNG Plier WITH GROOVED	105
OREGON PLUGGERS/CONDENSERS	51	SEPARATING ELASTIC PLIER	88	YOUNG TONGUE FORCEPS	99
ORTHO BAND PUSHER SCALER	88	SELDIN PERIOSTEEL ELEVATORS	95	YOUNG WIRE BENDING & LOOP FORMING PLIERS	99
ORTHO INSTRUMENT	97	SELDIN RETRACTOR	82	ZAHLE CEMENT SPATULAS	75
ORTHO LIGATURE DIRECTOR SINGLE ENDED	98	SELDIN ROOT ELEVATORS	15-18, 25		
ORTHO LIGHT BAND PUSHER SCALER	97-98	SELF LOCKING GROOVED	133		
ORTHO LIGHT DOUBLE ENDED LIGATURE DIRECTOR SCALER	98	SELF-LOCKING TWEezer	32		
ORTHO LIGHT DOUBLE ENDED LIGATURE DIRECTOR	98	SEMKEN TAYLOR TWEEZERS	31		
ORTHO LIGHT DOUBLE ENDED LIGATURE SCALER	98	SICKLE PERIODONTAL INSTRUMENTS	39		
ORTHO LIGHT DOUBLE ENDED LIGATURE SCALER/DIRECTOR	98	SICKLE SCALERS INSTRUMENTS	58		
ORTHO LIGHT LIGATURE DIRECTOR DOUBLE ENDED	98	SINGLE ENDED PROBE	33		
ORTHO LIGHT SCALER DOUBLE ENDED	97	SINUS LIFT ELEVATOR	115-116		



Vision Instrument Company

MANUFACTURER & EXPORTER OF FINE QUALITY
SURGICAL, DENTAL & BEAUTY, INSTRUMENT

Marala Road, Chowk Kotli Loharan, Sialkot - Pakistan

Tell : +92 344 6398925

E-mail : visioninstco@gmail.com info@visioninstco.com

URL : www.visioninstco.com